



User Guide

R1520

Industrial Dual SIM Cellular VPN Router



robustOS

Guangzhou Robustel Co., Ltd.

www.robustel.com

About This Document

This document provides hardware and software information of the Robustel High-speed intelligent LTE router R1520, including introduction, installation, configuration and operation.

Copyright©2022 Guangzhou Robustel Co., Ltd.

All rights reserved.

Trademarks and Permissions

robustel robustOS are trademark of Guangzhou Robustel Co., Ltd.. All other trademarks and trade names mentioned in this document are the property of their respective owners.

Disclaimer

No part of this document may be reproduced in any form without the written permission of the copyright owner. The contents of this document are subject to change without notice due to continued progress in methodology, design and manufacturing. Robustel shall have no liability for any error or damage of any kind resulting from the inappropriate use of this document.

Technical Support

Tel: +86-20-82321505

Email: support@robustel.com

Web: www.robustel.com

Important Notice

Due to the nature of wireless communications, transmission and reception of data can never be guaranteed. Data may be delayed, corrupted (i.e., have errors) or be totally lost. Although significant delays or losses of data are rare when wireless devices such as the router is used in a normal manner with a well-constructed network, the router should not be used in situations where failure to transmit or receive data could result in damage of any kind to the user or any other party, including but not limited to personal injury, death, or loss of property. Robustel accepts no responsibility for damages of any kind resulting from delays or errors in data transmitted or received using the router, or for failure of the router to transmit or receive such data.

Safety Precautions

General

- The router generates radio frequency (RF) power. When using the router, care must be taken on safety issues related to RF interference as well as regulations of RF equipment.
- Do not use your router in aircraft, hospitals, petrol stations or in places where using cellular products is prohibited.
- Be sure that the router will not be interfering with nearby equipment. For example: pacemakers or medical equipment. The antenna of the router should be away from computers, office equipment, home appliance, etc.
- An external antenna must be connected to the router for proper operation. Only uses approved antenna with the router. Please contact authorized distributor on finding an approved antenna.
- Always keep the antenna with minimum safety distance of 20 cm or more from human body. Do not put the antenna inside metallic box, containers, etc.
- RF exposure statements
 1. For mobile devices without co-location (the transmitting antenna is installed or located more than 20cm away from the body of user and nearby person)
- FCC RF Radiation Exposure Statement
 1. This Transmitter must not be co-located or operating in conjunction with any other antenna or transmitter.
 2. This equipment complies with FCC RF radiation exposure limits set forth for an uncontrolled environment. This equipment should be installed and operated with a minimum distance of 20 centimeters between the radiator and human body.

Note: Some airlines may permit the use of cellular phones while the aircraft is on the ground and the door is open. Router may be used at this time.

Using the Router in Vehicle

- Check for any regulation or law authorizing the use of cellular devices in vehicle in local country before installing the router.
- The driver or operator of any vehicle should not operate the router while driving.
- Install the router by qualified personnel. Consult your vehicle distributor for any possible interference of electronic parts by the router.
- The router should be connected to the vehicle's supply system by using a fuse-protected terminal in the vehicle's fuse box.
- Be careful when the router is powered by the vehicle's main battery. The battery may be drained after extended period.

Protecting Your Router

To ensure error-free usage, please install and operate your router with care. Do remember the following:

- Do not expose the router to extreme conditions such as high humidity / rain, high temperature, direct sunlight, caustic / harsh chemicals, dust, or water.
- Do not try to disassemble or modify the router. There is no user serviceable part inside and the warranty would be void.
- Do not drop, hit or shake the router. Do not use the router under extreme vibrating conditions.
- Do not pull the antenna or power supply cable. Attach/detach by holding the connector.
- Connect the router only according to the instruction manual. Failure to do it will void the warranty.
- In case of problem, please contact authorized distributor.

Regulatory and Type Approval Information

Table 1: Directives

2011/65/EU	<p>The European RoHS2.0 2011/65/EU Directive was issued by the European parliament and the European Council on 1 July 2011 on the restriction of the use of certain Hazardous substances in electrical and electronic equipment.</p> <p>On June 4, 2015, the Official Journal of the European Union published the RoHS2.0 Amendment Directive (EU)</p> <p>In 2015/863, four phthalates (DEHP, BBP, DBP, DIBP) were officially included in the list of restricted substances in Appendix II of RoHS 2.0 (2011/65/EU).</p> <p>From July 22, 2019, all electronic and electrical products exported to Europe (except medical and monitoring equipment) must meet this restriction; from July 22, 2021, medical equipment and monitoring equipment will also be included in the scope of control.</p>	
2012/19/EU	<p>The European WEEE 2012/19/EU Directive was issued by the European parliament and the European Council on 24 July 2012 on waste electrical and electronic equipment.</p>	
2013/56/EU	<p>The European 2013/56/EU Directive is a battery Directive which published in the EU official gazette on 10 December 2013. The button battery used in this product conforms to the standard of 2013/56/EU directive.</p>	

Table 2: Toxic or Hazardous Substances or Elements with Defined Concentration Limits

Name of the Part	Hazardous Substances									
	(Pb)	(Hg)	(Cd)	(Cr(VI))	(PBB)	(PBDE)	(DEHP)	(BBP)	(DBP)	(DIBP)
Metal parts	o	o	o	o	–	–	–	–	–	–
Circuit modules	o	o	o	o	o	o	o	o	o	o
Cables and cable assemblies	o	o	o	o	o	o	o	o	o	o
Plastic and polymeric parts	o	o	o	o	o	o	o	o	o	o

o:
Indicates that this toxic or hazardous substance contained in all of the homogeneous materials for this part is below the limit requirement in RoHS2.0.

X:
Indicates that this toxic or hazardous substance contained in at least one of the homogeneous materials for this part *might exceed* the limit requirement in RoHS2.0.

–:
Indicates that it does not contain the toxic or hazardous substance.

Document History

Updates between document versions are cumulative. Therefore, the latest document version contains all updates made to previous versions.

Date	Firmware Version	Document Version	Change Description
Jun 11, 2020	3.1.0	v.1.0.0	Initial release.
Oct 15, 2020	3.1.0	v.1.0.1	<ol style="list-style-type: none"> 1. Revise the maximum output current of DO. 2. Revise the description of DO. 3. Revise the picture of SIM Card Sticker.
May 28, 2021	3.1.9	v.1.0.2	<ol style="list-style-type: none"> 1. Ethernet cable becomes optional material. 2. Revise the description of LED indicators. 3. Revise the description of cellular. 4. Add Smart Roaming. 5. Add Edge2Cloud.
Dec. 25, 2021	3.1.9	v.1.0.3	<ol style="list-style-type: none"> 1. Revised the company name 2. Revised <i>Regulatory and Type Approval Information</i> 3. Revised <i>Disclaimer</i>

Contents

Chapter 1	Product Overview.....	9
1.1	Introduction.....	9
1.2	Package Contents.....	9
1.3	Specifications.....	12
1.4	Dimensions.....	13
Chapter 2	Hardware Installation.....	14
2.1	Definition of Power Interface.....	14
2.2	Interface Definition of 2 * 3 3.5mm.....	14
2.3	Interface Definition of 2 * 4 3.5mm.....	15
2.4	LED indicator.....	16
2.5	USB Interface.....	17
2.6	Reset Button.....	18
2.7	Ethernet Ports.....	18
2.8	Insert or Remove SIM Card.....	19
2.9	Attach External Antenna (SMA Type).....	20
2.10	Mount the Router.....	21
2.11	Connect the Router to a Computer.....	23
2.12	Power Supply.....	23
2.13	DI/DO Interface.....	24
2.14	AI Interface.....	25
Chapter 3	Initial Configuration.....	26
3.1	Configure the PC.....	26
3.2	Factory Default Settings.....	28
3.3	Log in the Router.....	29
3.4	Control Panel.....	29
Chapter 4	Router Configuration.....	32
4.1	Status.....	32
4.1.1	System Information.....	32
4.1.2	Internet Status.....	33
4.1.3	LAN Status.....	33
4.2	Interface.....	34
4.2.1	Link Manager.....	34
4.2.2	LAN.....	45
4.2.3	Ethernet.....	49
4.2.4	Cellular.....	50
4.2.5	WiFi.....	55
4.2.6	USB.....	63
4.2.7	DI/DO.....	64
4.2.8	AI.....	68
4.2.9	Serial Port.....	70
4.3	Network.....	74
4.3.1	Route.....	74
4.3.2	Firewall.....	76
4.3.3	IP Passthrough.....	81

4.4	VPN.....	82
4.4.1	IPsec.....	82
4.4.2	OpenVPN.....	90
4.4.3	GRE.....	103
4.5	Services.....	104
4.5.1	Syslog.....	104
4.5.2	Event.....	105
4.5.3	NTP.....	109
4.5.4	SMS.....	110
4.5.5	Email.....	111
4.5.6	DDNS.....	112
4.5.7	SSH.....	113
4.5.8	GPS (Optional).....	114
4.5.9	Web Server.....	119
4.5.10	Advanced.....	120
4.5.11	Smart Roaming.....	121
4.6	System.....	125
4.6.1	Debug.....	125
4.6.2	Update.....	126
4.6.3	App Center.....	126
4.6.4	Tools.....	127
4.6.5	Profile.....	130
4.6.6	User Management.....	132
4.7	Edge2cloud.....	133
4.7.1	Edge2cloud.....	133
4.7.2	E2C Broker.....	133
Chapter 5	Configuration Examples.....	136
5.1	Cellular.....	136
5.1.1	Cellular Dial-Up.....	136
5.1.2	SMS Remote Control.....	138
5.2	VPN Configuration Example.....	140
5.2.1	IPsec VPN.....	140
5.2.2	OpenVPN.....	144
5.2.3	GRE VPN.....	146
Chapter 6	Introductions for CLI.....	148
6.1	What Is CLI.....	148
6.2	How to Configure the CLI.....	150
6.3	Commands Reference.....	150
6.4	Quick Start with Configuration Examples.....	151
Glossary.....		158

Chapter 1 Product Overview

1.1 Introduction

The Robustel industrial dual SIM cellular VPN router (R1520) is a rugged cellular router can support 2G, 3G, and 4G LTE Cat 4 networks. It provides high-speed wireless network bandwidth for devices through wireless connections to ensure stable wireless network connections.

R1520 is a powerful router developed from RobustOS, a Robustel self-developed and Linux-based operating system which is designed to be used in Robustel devices. The RobustOS includes basic networking features and protocols providing customers with a very good customized user experience, which is more diverse, convenient, and practical. Meanwhile, Robustel offers a Software Development Kit (SDK) for partners and customers to allow additional customization by using C. It also provides rich Apps to meet fragmented IoT market demands.

1.2 Package Contents

Before installing your R1520 Router, verify the kit contents as following.

Note: The following pictures are for illustration purposes only, not based on their actual sizes.

- 1 x Robustel R1520 High-speed intelligent LTE router



- 1 x 2-pin 3.5 mm male terminal block with lock for power supply



- 1 x 2*4-pin 3.5 mm male terminal block for serial port



- RP-SMA-J WiFi antenna (rubber antenna or Magnet antenna is optional)
rubber antenna Magnet antenna



- SMA-J GPS antenna (Magnetic or adhesive is optional)



- 35 mm DIN Rail mounting kit

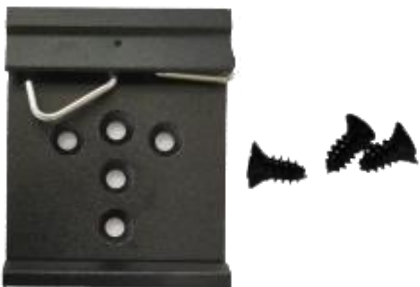

- AC/DC power adapter (12V DC, 1.5 A; EU/US/UK/AU plug optional)



1.3 Specifications

Cellular Interface

- Number of antennas: 2 (MAIN + AUX)
- Connector: SMA-K
- SIM: 2 , Mini-SIM or eSIM
- Standards: FDD LTE/TDD LTE, backward compatible to 2G/3G

Ethernet Interface

- Number of ports: 5 x 10/100 Mbps (It can be configured as 5x LAN or 4 x LAN + 1 x WAN)
- ETH0 port: supports 802.3at PD function
- Magnet isolation protection: 1.5 KV

WiFi Interface

- Number of antennas: 2 (WiFi1 + WiFi2)
- Connector: RP-SMA-K
- Standards: 802.11b/g/n, 2*2 MIMO, supports AP and Client modes
- Frequency bands: 2.4GHz
- Security: Open、WPA、WPA2、WEP
- Encryption: AES、TKIP、WEP64
- Data speed: Maximum rate is 300 Mbps

GPS Interface (Optional, depending on the cellular module)

- Number of antennas: 1
- Connector: SMA-K, 50 ohm characteristic impedance
- Positioning technology: GPS, QZSS, GLONASS, Galileo, BeiDou

Serial Interface

- Number of ports: 1 x RS232 and 1 x RS485
- Connector: 2 *4-pin 3.5 mm female socket
- ESD protection: ± 8 KV Air
- RS232: TxD, RxD, RTS, CTS, SGND
- RS485: Data+ (A), Data- (B)

DI/DO

- Type: 1 x DI (wet contact) + 1 x DO (wet contact)
- Connector: 2*3-pin 3.5 mm female socket
- Isolation: 3KVDC
- Absolute maximum : "V+" + 30 V DC (DI, 30 V DC (DO)
- Maximum input current of DI: 10 mA
- Maximum output current of DO: 10 mA

Analog Input

- Type: 1 x AI
- Connector: 2*3-pin 3.5 mm female socket(Shared with DI / DO)

- Measuring range: 4 ~ 20mA / 0 ~ 24V

Others

- 1 x Reset button (Tact Switch)
- 1 x 480 Mbps high-speed USB 2.0 interface (host mode), Type A, 5V / 500 mA
- LED indicators - 1 x RUN, 1 x Modem, 1 x USR, 1 x WiFi, 1 x RSSI

Power Supply and Consumption

- Connector: 2-pin 3.5 mm female socket with lock
- Input voltage: 9 to 36V DC
- Power consumption: Idle: 100 mA@12 V;
Data link: 1000 mA (peak) @12 V

Physical Characteristics

- Ingress protection: IP30
- Housing & Weight: Plastic, 250 g
- Dimensions: 105mm (length) x 90mm(width) x 46mm(thickness)
- Installations: Desktop, wall mounting or DIN rail mounting (Wall mounting and Din rail mounting installation requires additional installation accessories)
- Operating Temperature: -25~+70 °C
- Storage Temperature: -40~+85 °C
- Relative Humidity: 5~95% RH

1.4 Dimensions

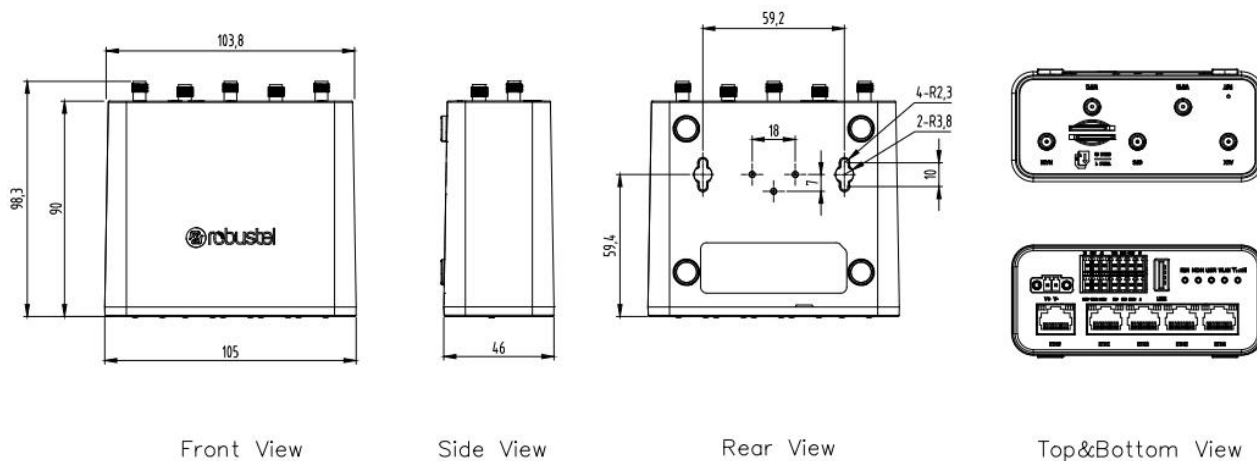

Chapter 2 Hardware Installation

2.1 Definition of Power Interface



PIN	Description	Note
1	V+	Positive
2	V-	Negative

2.2 Interface Definition of 2 * 3 3.5mm



PIN	DI	DO	AI	Note
1	IN		--	Digital input positive
2	--	OUT	--	Digital output positive
3	--	--	AI	Analog input
4	IGND	--	--	Digital input negative
5	--	OGND	--	Digital output negative
6	--	--	AGND	Analog input signal ground

2.3 Interface Definition of 2 * 4 3.5mm



PIN	RS232	RS485	Note
1	TXD	--	Router → Device
2	RTS	--	Router → Device
3	--	GND	RS485 signal ground
4		B	RS485 Data+ (B)
5	RXD	--	Router ← Device
6	CTS	--	Router ← Device
7	SGND	--	RS232 signal ground
8	--	A	RS485 Data+ (A)

2.4 LED indicator



Name	Color	Status	Description	
RUN	Green	On, solid	Router is powered on (System is initializing)	
		On, blinking	Router starts operating	
		Off	Router is powered off	
MDM	Green	On, solid	Link connection is working	
		On, blinking	Data is sent and received.	
		Off	Link connection is not working	
USR	USR-OpenVPN	Green	On, solid	OpenVPN connection is established
		Off	OpenVPN connection is not established	
	USR-IPsec	Green	On, solid	IPsec connection is established
		Off	IPsec connection is not established	
RSSI	Green	On, solid	Received Signal Strength Indication greater than -73 dBm (Strong signal)	
	Green	On, blinking	Received Signal Strength Indication -91 to -73 dBm (Moderate signal)	
	Green	Off	Received Signal Strength Indication -111 to -93dBm (Weak signal)	
	Green	Off	No signal	
WLAN	Green	On, solid	WiFi is enabled and working properly	
	Green	Off	WiFi is disabled or not working properly	

Note: 1. click Services > Advanced > system > System Settings > Custom LED Indicator type to set the display type of USR LED.

2. When the LEDs start blinking one by one, the WLAN indicator will not turn on and off.

2.5 USB Interface

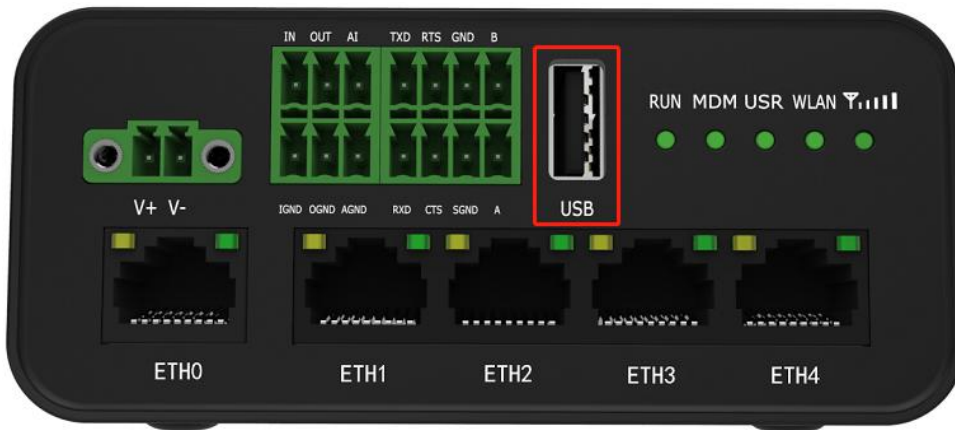

Function	Operation
Firmware upgrade	The USB interface can be used for batch firmware upgrades, but it cannot send or receive data with slave devices connected to the USB interface. The user can insert a USB storage device, such as a U disk or a hard disk, at the USB interface. If there is a configuration file or router firmware in the USB storage device, the router will automatically update the configuration file or firmware. For details, please refer to "4.2.6 USB".

2.6 Reset Button



Function	Operation
Reboot	Press and hold the RST button for 2 to 7 seconds under the operating status.
Restore to factory default settings	Wait for 0~20 seconds after powering up the router, press and hold the RST button with a pointed bar until all five LEDs start blinking one by one, and release the button to return the router to factory defaults.

2.7 Ethernet Ports



There are five Ethernet ports on R1520, including ETH0 (POE), ETH1, ETH2, ETH3 and ETH4. Each has two LED indicators. The green one is a link indicator but the yellow one doesn't mean anything. For details about status, see the table below.

Indicator	Status	Description
Link indicator (Green)	On, solid	Connection is established
	On, blinking	Data is being transferred
	Off	Connection is not established

2.8 Insert or Remove SIM Card

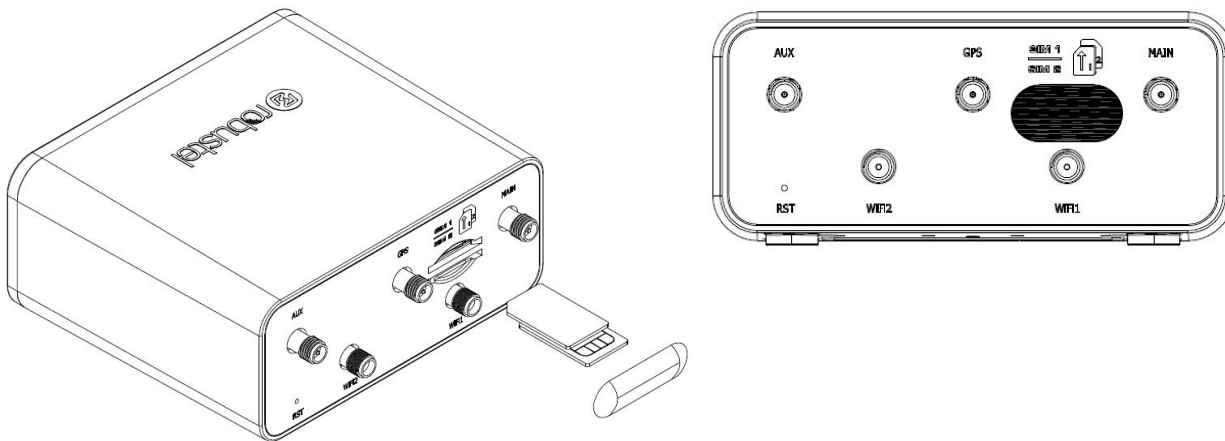

Insert or remove the SIM card as shown in the following steps.

- **Insert SIM card**

1. Make sure router is powered off.
2. To insert SIM card, press the card with finger until you hear a click.
3. After the SIM card is inserted, attach the SIM card sticker to the card slot.

- **Remove SIM card**

1. Make sure router is powered off.
2. Tear the SIM card sticker from the slot.
3. To remove SIM card, press the SIM card with finger until you hear a click and it pops out and then take out the card.

Note:

1. Use the specific M2M SIM card when the device is working in extreme temperature, because the regular card for long-time working in harsh environment will be disconnected frequently.
2. Do not touch the metal of the card surface in case information in the card will lose or be destroyed.
3. Do not bend or scratch the card.
4. Keep the card away from electricity and magnetism.
5. Make sure router is powered off before inserting or removing the card.

2.9 Attach External Antenna (SMA Type)

Attach an external SMA antenna to the router's antenna connector and twist tightly. Make sure the antenna is within the correct frequency range provided by the ISP and with 50 Ohm impedance.

Note: Recommended torque for tightening is 0.35 N.m.

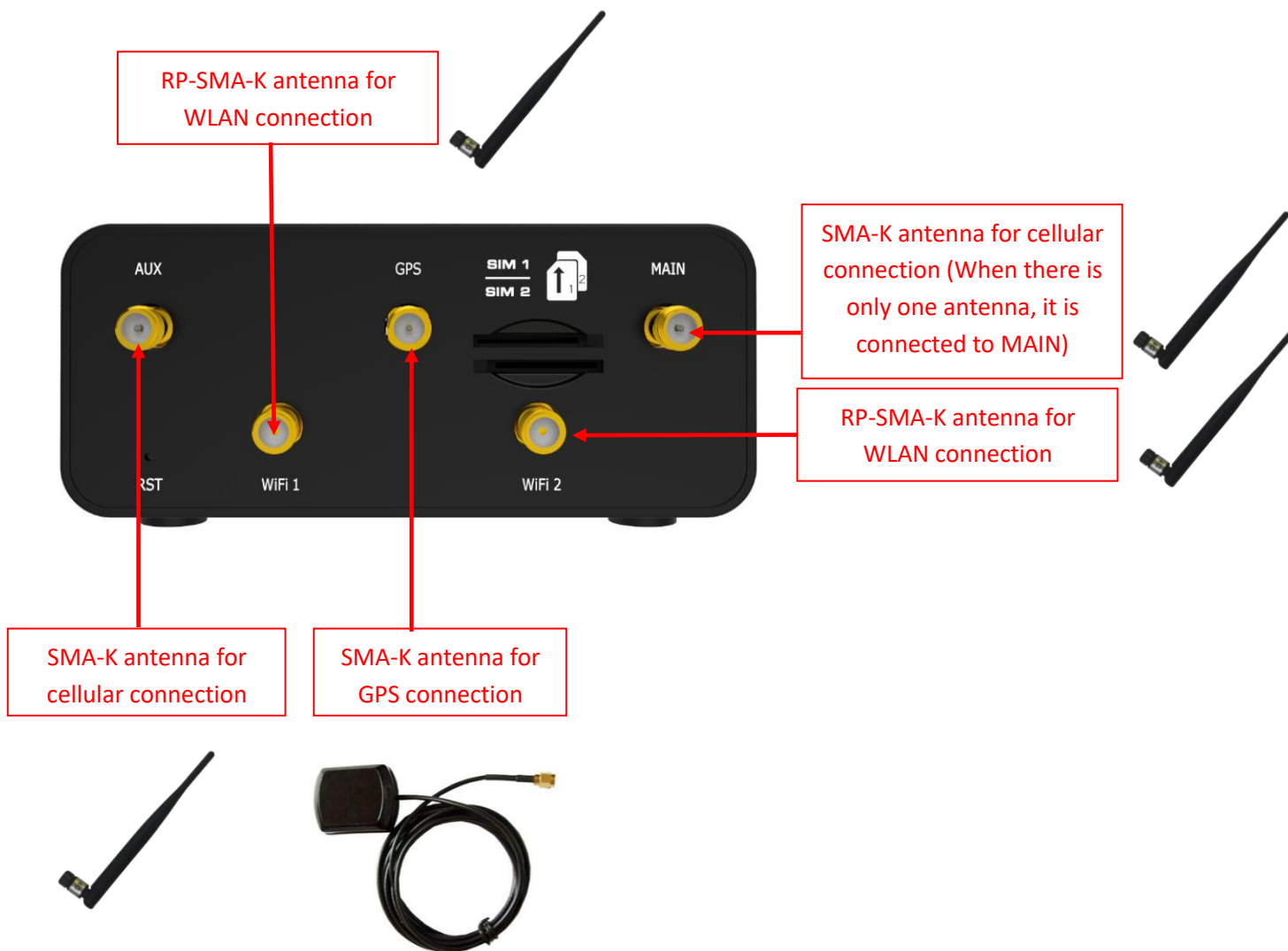

2.10 Mount the Router

The router can be placed on a desktop or mounted to a wall or a 35 mm DIN rail.

Two methods for mounting the router

1. Wall mounting (measured in mm)

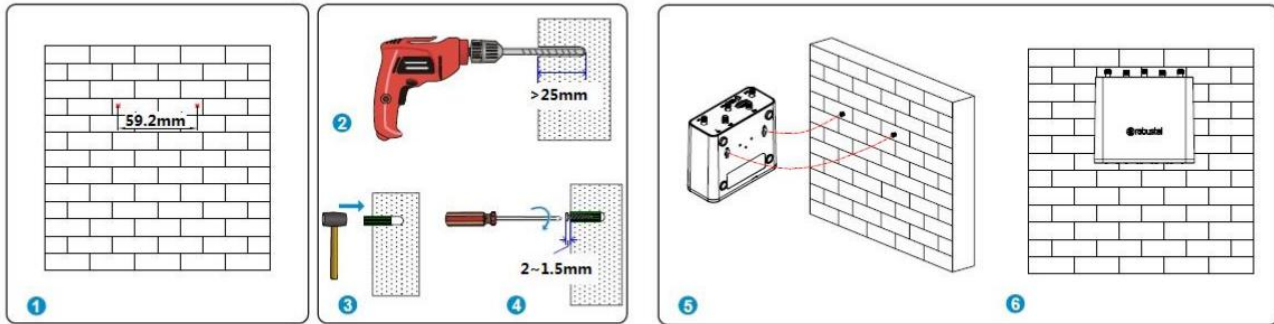

First, drill holes on the wall, the distance between the two holes is 60mm, then knock the expansion pipe into the wall with a rubber hammer, align the screw with the expansion pipe, insert the screw and reserve the corresponding length, and finally fix the product on the wall.

Note: Recommended torque for mounting is 1.0 N.m, and the maximum allowed is 1.2 N.m.

2. DIN rail mounting (measured in mm)

Option 1: Vertical installation

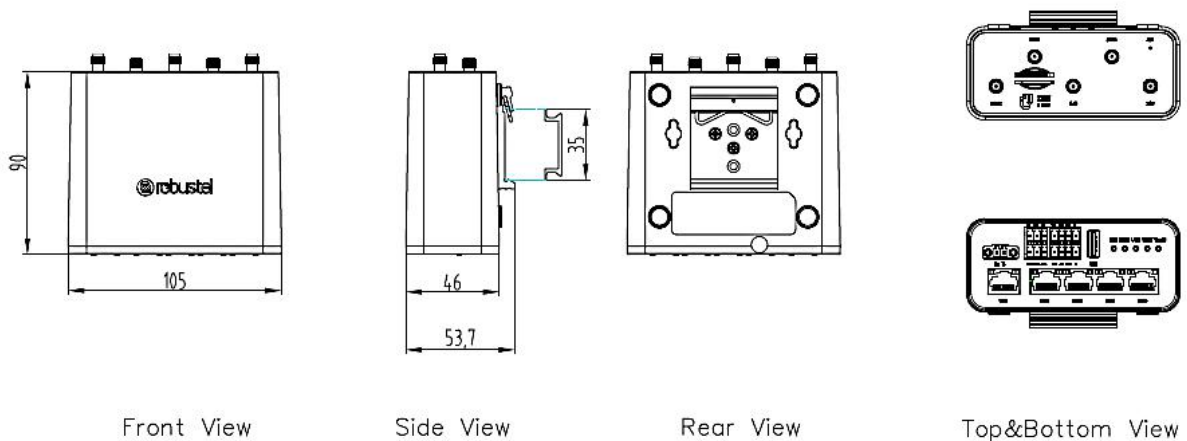

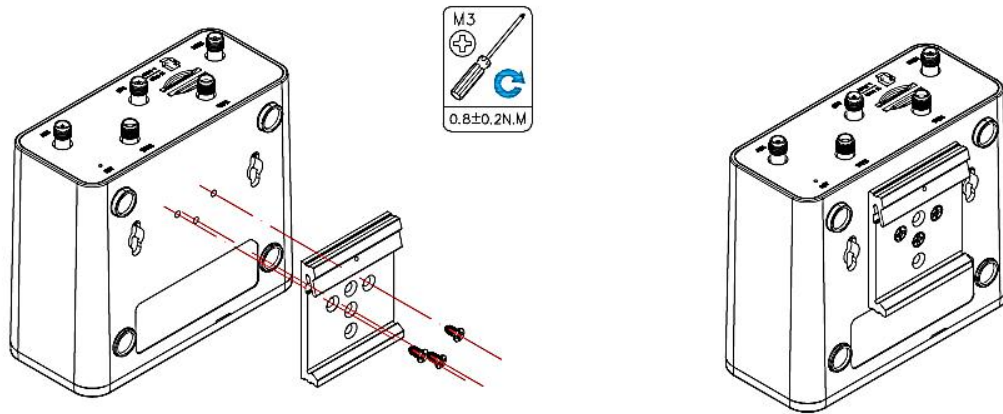

Use 3 pcs of M3*8 Black cross recessed countersunk head tapping screws to mount the router on the DIN rail, and then hang the DIN rail on the holder. You need to choose a standard holder.

Note: Recommended torque for mounting is 0.8 N.m, and the maximum allowed is 1.0 N.m.

Option 2: Horizontal installation

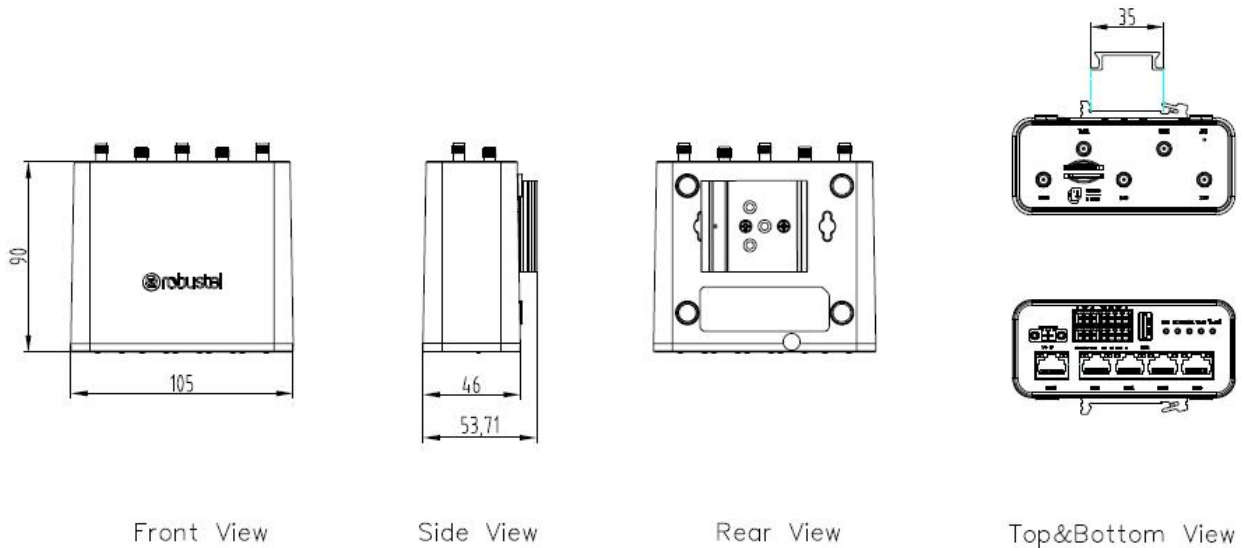

Front View

Side View

Rear View

Top&Bottom View

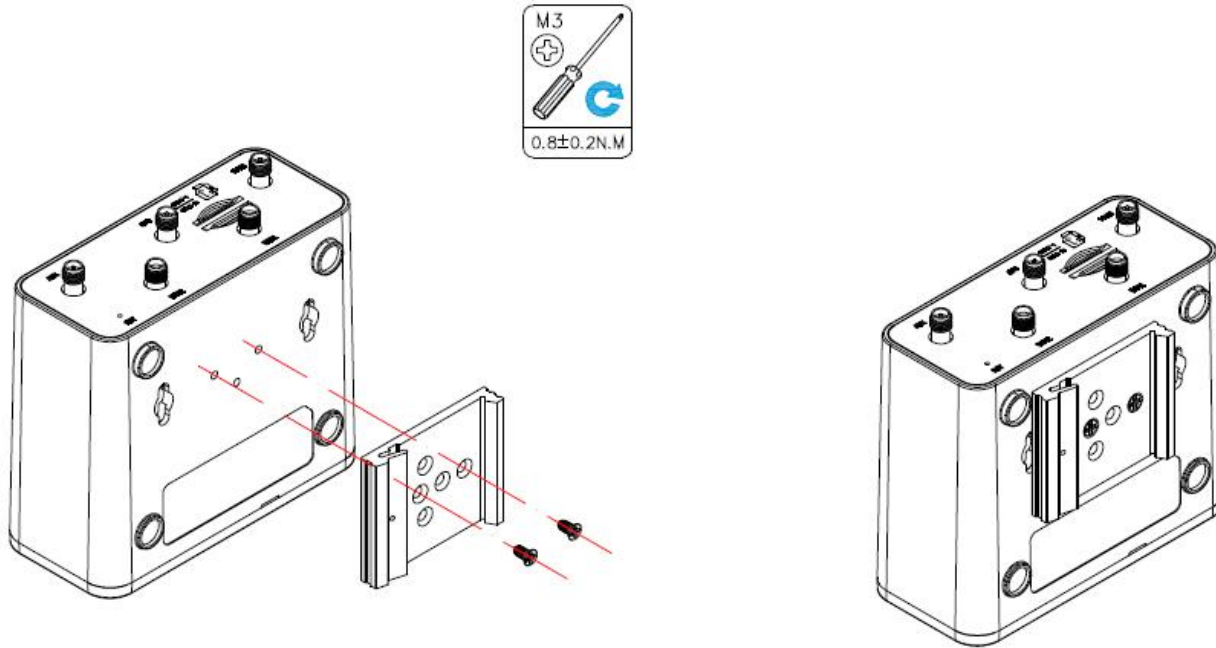

Use 3 pcs of M3*8 Black cross recessed countersunk head tapping screws to mount the router on the DIN rail, and then hang the DIN rail on the holder. You need to choose a standard holder.

Note: Recommended torque for mounting is 0.8 N.m, and the maximum allowed is 1.0 N.m.

2.11 Connect the Router to a Computer

Connect the Ethernet port (ETH1 ~ ETH4) of the router to a PC with a standard crossover cable.

2.12 Power Supply

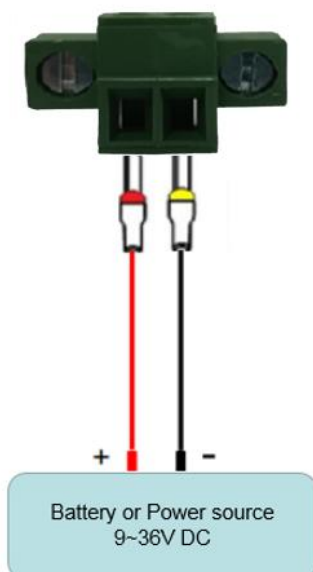

PIN	Description	Note
1	Power supply Positive	Connect the adapter or battery positive (red wire)
2	Power supply negative	Connect the adapter or battery negative (black wire)

2.13 DI/DO Interface

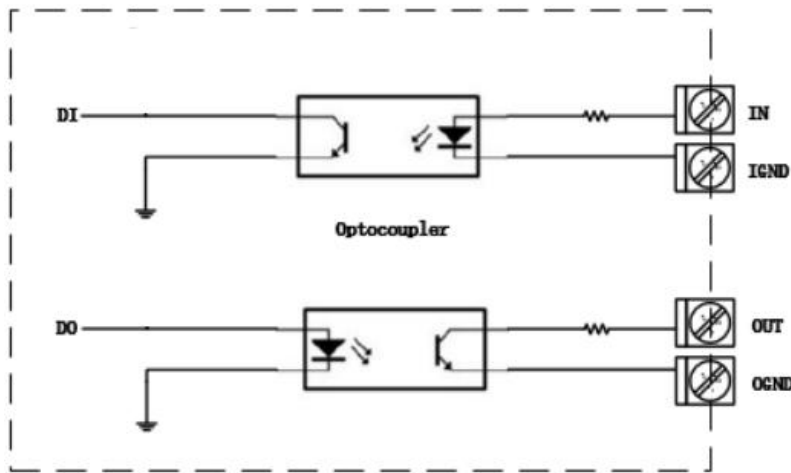

R1520 supports 1 channel DI and 1 channel DO, the internal schematic diagram is as shown above;

1. DI application

R1520 DI input is internally isolated by opt coupler, internal current-limiting design, within the working level of 0 ~ 30V, external input does not need current limiting, DI input logic level range is as follows:

Logic 1 level range: min 3.5 V to max 30 V;

Logic 0 level range: min 0 V to max 1 V;

The application example is as follows:

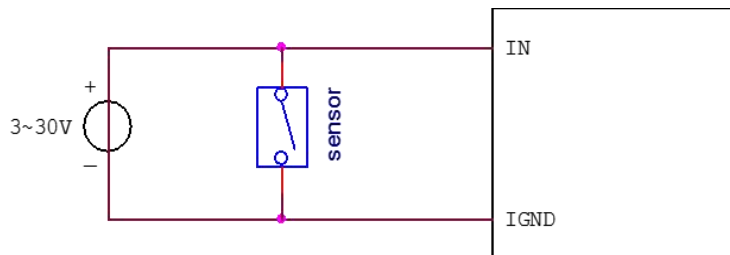

2. DO application

R1520 DO output is internally isolated by opt coupler, OUT is OC gate output, Normal use requires external resistor pull-up, the pull-up voltage range is 3V ~ 30V (for actual use, please consult Technical Support Engineer for selection of pull-up resistor);

The application example is as follows:

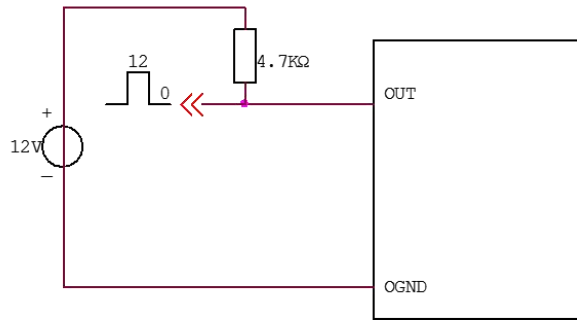

2.14 AI Interface

R1520 supports one channel AI interface for analog signal voltage and current measurement;

1. 0 ~ 24V voltage measurement, wiring as shown below:

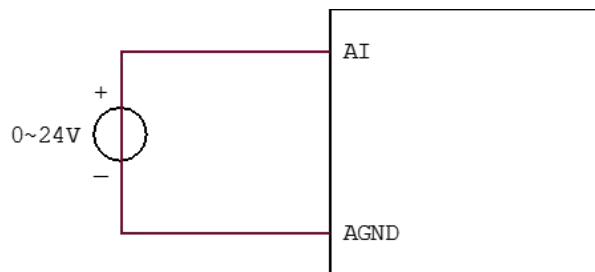

2. 4 ~ 20mA current signal measurement requires an external parallel 1.2kohm resistor, wiring as shown below:

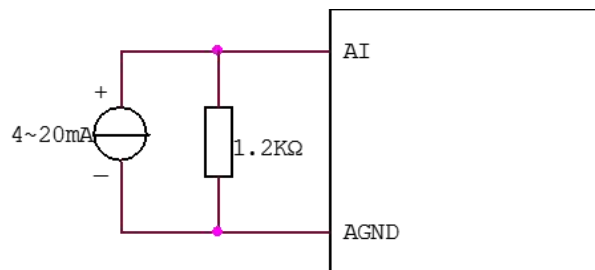

Chapter 3 Initial Configuration

The router can be configured through your web browser that including IE 8.0 or above, Chrome and Firefox, etc. A web browser is included as a standard application in the following operating systems: Linux, Mac OS, Windows 98/NT/2000/XP/Me/Vista/7/8, etc. It provides an easy and user-friendly interface for configuration. There are various ways to connect the router, either through an external repeater/hub or connect directly to your PC. However, make sure that your PC has an Ethernet interface properly installed prior to connecting the router. You must configure your PC to obtain an IP address through a DHCP server or a fixed IP address that must be in the same subnet as the router. If you encounter any problems accessing the router web interface, it is advisable to uninstall your firewall program on your PC, as this tends to cause problems accessing the IP address of the router.

3.1 Configure the PC

There are two methods to get IP address for the PC. One is to obtain an IP address automatically from “Local Area Connection”, and another is to configure a static IP address manually within the same subnet of the router. Please refer to the steps below.

Here take **Windows 7** as example, and the configuration for windows system is similar.

1. Click **Start > Control Panel**, double-click **Network and Internet**, and then double-click **Network Connections**.

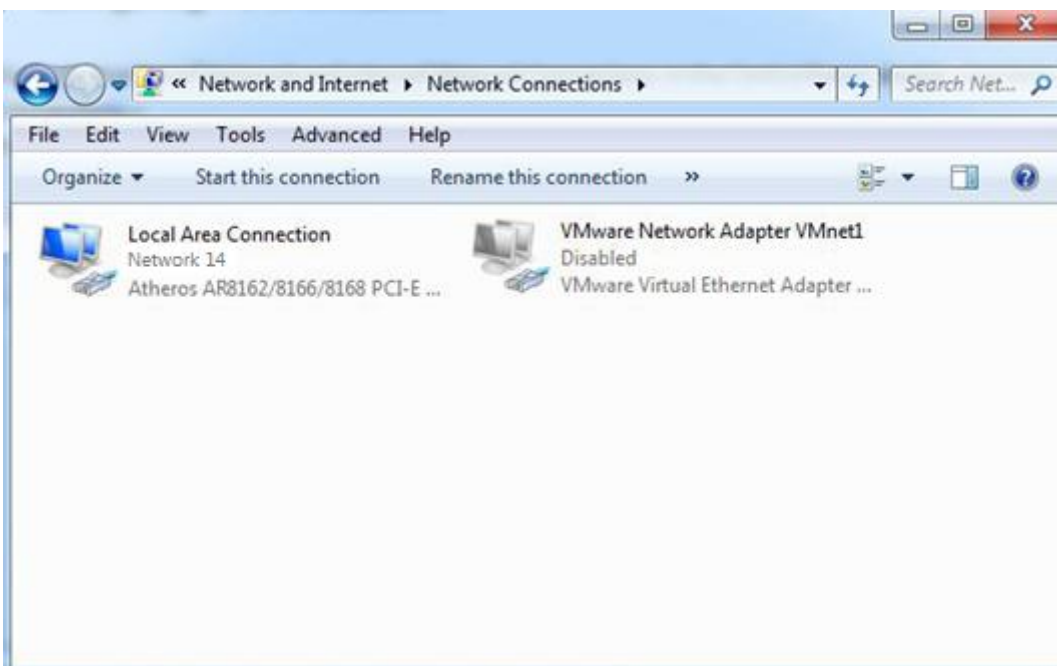

2. Click **Properties** in the window of **Local Area Connection Status**.

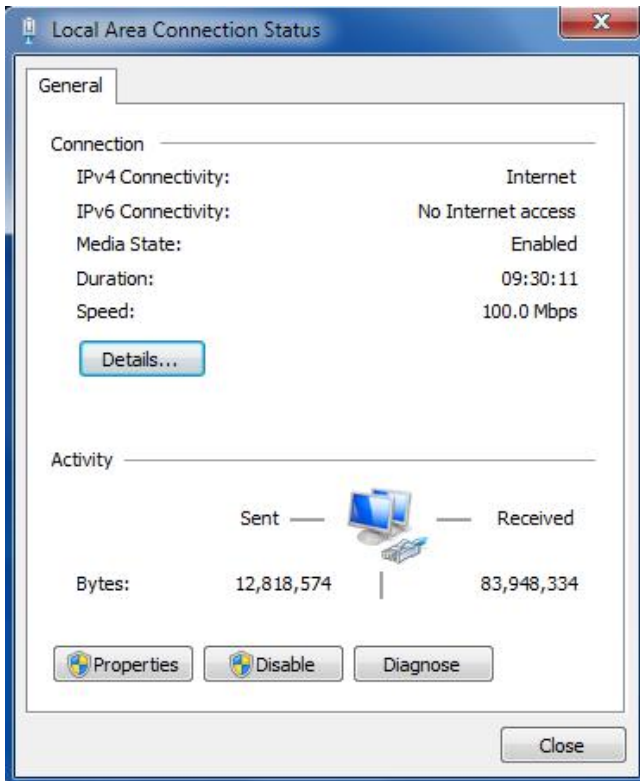

3. Choose **Internet Protocol Version 4 (TCP/IPv4)** and click **Properties**.

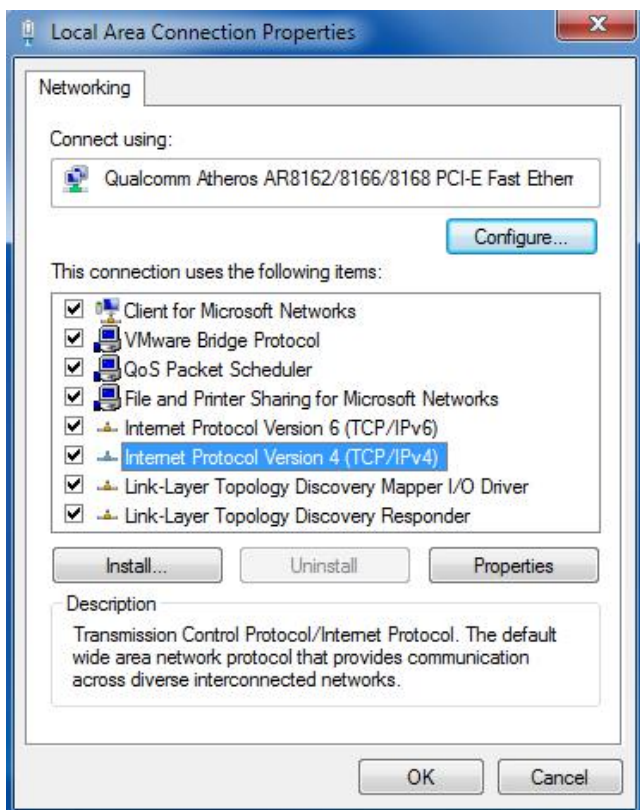

4. Two ways for configuring the IP address of PC

Obtain an IP address from the DHCP server automatically; Click **"Obtain an IP address automatically"**;

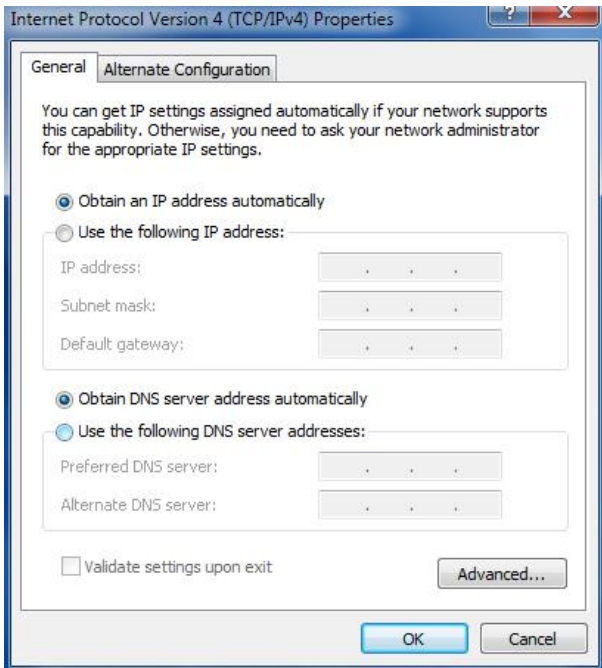

Use the following IP address:

(Configured a static IP address manually within the same subnet of the router, click and configure **"Use the following IP address"**)

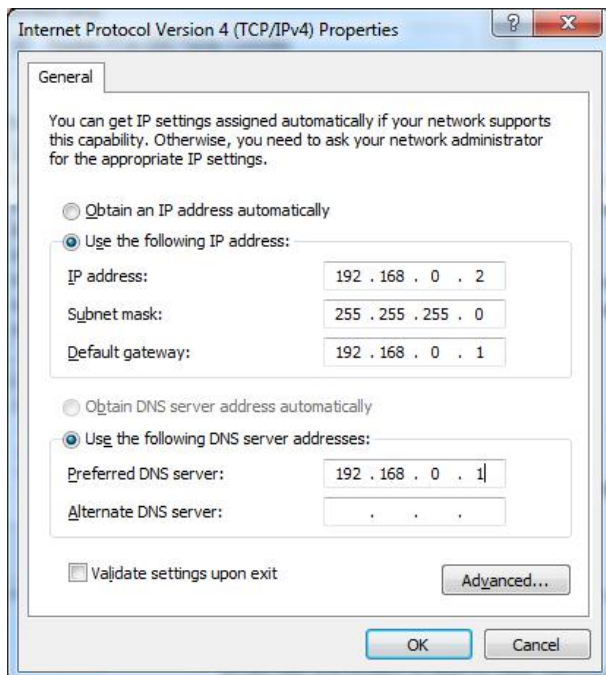

5. Click **OK** to finish the configuration.

3.2 Factory Default Settings

Before configuring your router, you need to know the following default settings.

Item	Description
Username	admin
Password	admin
ETH0/POE	Default WAN mode
ETH1	192.168.0.1/255.255.255.0, LAN mode
ETH2	192.168.0.1/255.255.255.0, LAN mode
ETH3	192.168.0.1/255.255.255.0, LAN mode
ETH4	192.168.0.1/255.255.255.0, LAN mode
DHCP Server	Enabled

3.3 Log in the Router

To log in to the management page and view the configuration status of your router, please follow the steps below.

1. On your PC, open a web browser such as Internet Explorer and Google, etc.
2. From your web browser, type the IP address of the router into the address bar and press enter. The default IP address of the router is <http://192.168.0.1/>, though the actual address may vary.

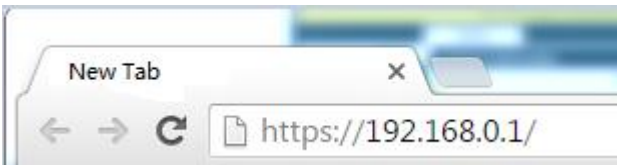

3. In the login page, enter the username and password, choose language and then click **LOGIN**. The default username and password are “admin”.

Note: If enter the wrong username or password over 6 times, the login web will be locked for 5 minutes.



3.4 Control Panel

After successfully logging into the R1520 router, the home page is as shown in the figure below:

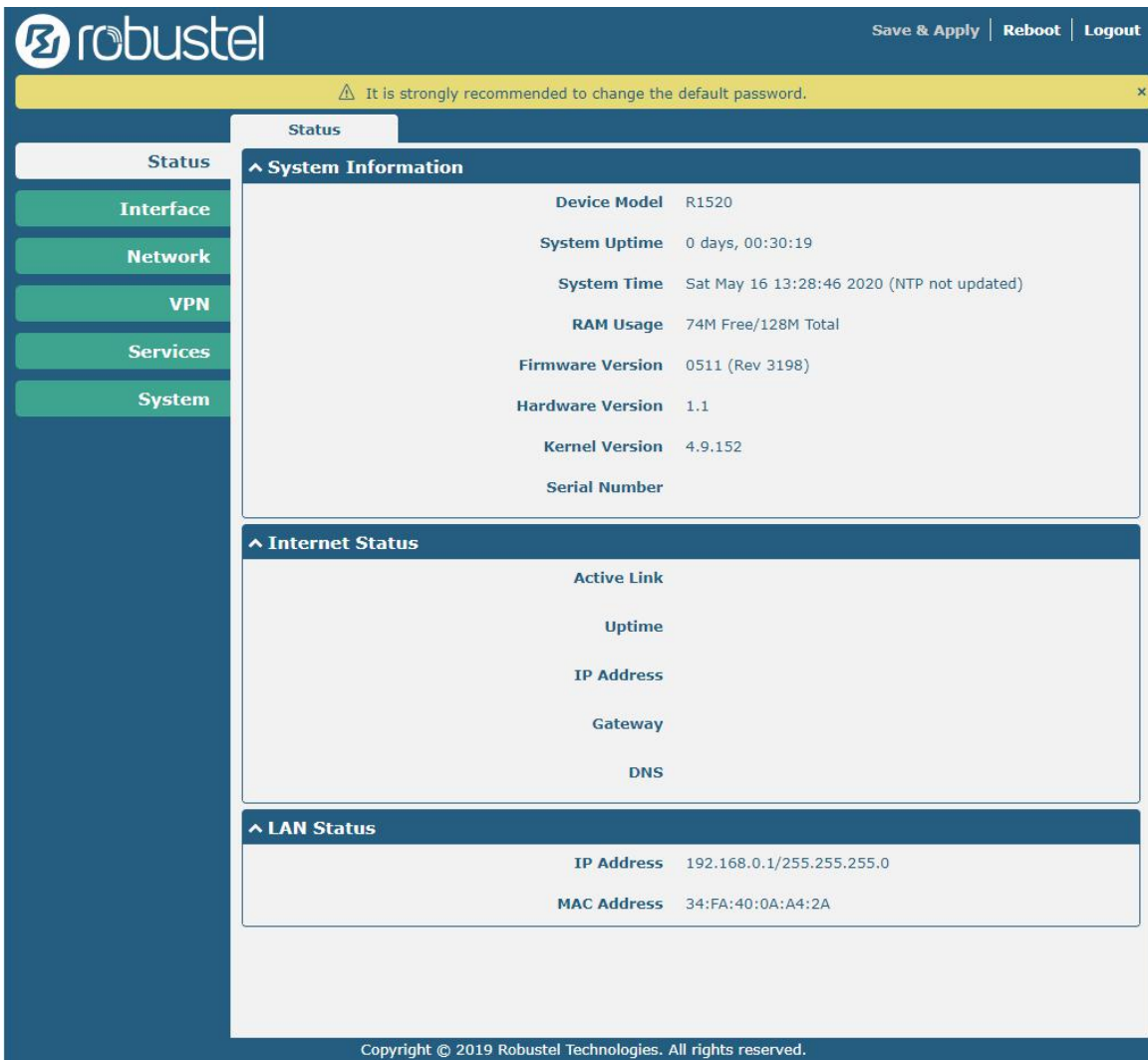

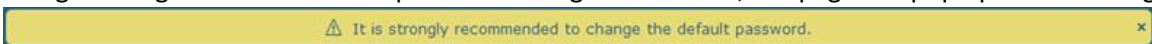

In the home page, the user can save the configuration, restart the router, log out, and so on. Using the original username and password to log in the router, the page will pop up the following tab.





It is strongly recommended for security purposes that you change the default username and/or password.

Click the to close the popup. To change your username and/or password, see **4.6.6 User Management**.

Control Panel		
Item	Description	Button
Save & Apply	Click to save the current configuration into router’s flash and apply the modification on every configuration page, to make the modification taking effect.	
Reboot	Click to reboot the router. If the Reboot button is yellow, it means that some completed configurations will take effect only after reboot.	
Logout	Click to log the current user out safely. After logging out, it will switch to login page. Shut down web page directly without logout, the next one can login web on this browser without a password before timeout.	

Submit	Click to save the modification on current configuration page.	
Cancel	Click to cancel the modification on current configuration page.	

Note: The steps of how to modify configuration are as bellow:

1. Modify in one page;
2. Click  under this page;
3. Modify in another page;
4. Click  under this page;
5. Complete all modification;
6. Click .

Chapter 4 Router Configuration

4.1 Status

4.1.1 System Information

This section allows you to view the System Information of your Router.

^ System Information	
Device Model	R1520
System Uptime	0 days, 01:45:48
System Time	Sat May 16 14:44:15 2020 (NTP not updated)
RAM Usage	76M Free/128M Total
Firmware Version	0511 (Rev 3198)
Hardware Version	1.1
Kernel Version	4.9.152
Serial Number	

System Information	
Item	Description
Device Model	Show the model name of your device.
System Uptime	Show the current amount of time the router has been connected.
System Time	Show the current system time.
RAM Usage	Show the free memory and the total memory.
Firmware Version	Show the firmware version running on the router.
Hardware Version	Show the current hardware version.
Kernel Version	Show the current kernel version.
Serial Number	Show the serial number of your device, from which you can get information such as the router's time of delivery.

4.1.2 Internet Status

This section shows the Internet status information of your Router.

^ Internet Status	
Active Link	WWAN1
Uptime	0 days, 00:39:31
IP Address	10.122.74.11/255.255.255.248
Gateway	10.122.74.9
DNS	210.21.4.130 221.5.88.88

Internet Status	
Item	Description
Active Link	Show the current active link. WWAN1, WWAN2, WAN or WLAN.
Uptime	Show the current amount of time the link has been connected.
IP Address	Show the IP address of current link.
Gateway	Show the gateway address of the current link.
DNS	Show the current primary DNS server and secondary server.

4.1.3 LAN Status

This section shows the router's LAN status information.

^ LAN Status	
IP Address	192.168.0.1/255.255.255.0
MAC Address	34:FA:40:0A:A4:2A

LAN Status	
Item	Description
IP Address	Show the IP address and the Netmask of the router.
MAC Address	Show the MAC address of the router.

4.2 Interface

4.2.1 Link Manager

This section allows you to setup the connection of Link Manager. Link manager is a network link backup function that provides mobile network and Ethernet link backups.

Link Manager
Status

^ General Settings

Primary Link ?

Backup Link ?

Backup Mode ?

Revert Interval ?

Emergency Reboot ON OFF ?

General Settings @ Link Manager		
Item	Description	Default
Primary Link	Select from “WWAN1”, “WWAN2”, “WAN” or “WLAN”. <ul style="list-style-type: none"> • WWAN1: Select to make SIM1 as the primary wireless link • WWAN2: Select to make SIM2 as the primary wireless link • WAN: Select to make WAN as the primary wired link • WLAN: Select to make WLAN as the primary wireless link Note: WLAN link is available only if enable WiFi as Client mode, please refer to 4.2.5 WiFi .	WWAN1
Backup Link	Select from “WWAN1”, “WWAN2”, “WAN” or “None”. <ul style="list-style-type: none"> • WWAN1: Select to make SIM1 as the backup wireless link • WWAN2: Select to make SIM2 as the backup wireless link • WAN: Select to make WAN as the backup wired link • WLAN: Select to make WLAN as the backup wireless link Note: WLAN link is available only if enable WiFi as Client mode, please refer to 4.2.5 WiFi . <ul style="list-style-type: none"> • None: Do not select any backup link 	WWAN2
Backup Mode	Select from “Cold Backup”, “Warm Backup” or “Load Balancing”. <ul style="list-style-type: none"> • Cold Backup: The inactive link is offline on standby • Warm Backup: The inactive link is online on standby Note: Warm backup mode is not available for dual SIM backup. <ul style="list-style-type: none"> • Load Balancing: Use two links simultaneously 	Cold Backup
Revert Interval	Specify the number of minutes that elapses before the primary link is checked if a backup link is being used in cold backup mode. 0 means disable checking. Note: Revert interval is available only under the cold backup mode.	0
Emergency Reboot	Click the toggle button to enable/disable this option. Enable to reboot the whole system if no links available.	OFF

Note: Click ? for help.

Link Settings allows you to configure the parameters of link connection, including WWAN1, WWAN2, WAN and WLAN. It is recommended to enable Ping detection to keep the router always online. The Ping detection increases the reliability and also costs the data traffic.

^ Link Settings				
Index	Type	Description	Connection Type	
1	WWAN1		DHCP	
2	WWAN2		DHCP	
3	WAN		DHCP	
4	WLAN		DHCP	

Click on the right-most of WWAN1/WWAN2/WAN/WLAN to enter the configuration window.

WWAN1/ WWAN2

Link Manager

^ General Settings

Index

Type

Description

The window is displayed as below when enabling the “Automatic APN Selection” option.

^ WWAN Settings

Automatic APN Selection ON OFF

Dialup Number

Authentication Type

Switch SIM By Data Allowance OFF ?

Data Allowance ?

Billing Day ?

The window is displayed as below when disabling the “Automatic APN Selection” option.

^ WWAN Settings

Automatic APN Selection ON OFF

APN

Username

Password

Dialup Number

Authentication Type v

Switch SIM By Data Allowance ON OFF ?

Data Allowance ?

Billing Day ?

^ Ping Detection Settings ?

Enable ON OFF

Primary Server

Secondary Server

Interval ?

Retry Interval ?

Timeout ?

Max Ping Tries ?

^ Advanced Settings

NAT Enable ON OFF

Upload Bandwidth ?

Download Bandwidth

Overrided Primary DNS

Overrided Secondary DNS

Debug Enable ON OFF

Verbose Debug Enable ON OFF

Link Settings (WWAN)		
Item	Description	Default
General Settings		
Index	Indicate the ordinal of the list.	--
Type	Show the type of the link.	WWAN1
Description	Enter a description for this link. It can be null.	Null
WWAN Settings		
Automatic APN	Click the toggle button to enable/disable the "Automatic APN Selection"	ON

Link Settings (WWAN)		
Item	Description	Default
Selection	option. After enabling, the device will recognize the access point name automatically. Alternatively, you can disable this option and manually add the access point name.	
APN	Enter the Access Point Name for cellular dial-up connection, provided by local ISP.	internet
Username	Enter the username for cellular dial-up connection, provided by local ISP.	Null
Password	Enter the password for cellular dial-up connection, provided by local ISP.	Null
Dialup Number	Enter the dialup number for cellular dial-up connection, provided by local ISP.	*99***1#
Authentication Type	Select from "Auto", "PAP" or "CHAP" as the local ISP required.	Auto
Switch SIM By Data Allowance	Click the toggle button to enable/disable this option. After enabling, it will switch to another SIM when the data limit reached. Note: Only used for dual SIM backup.	OFF
Data Allowance	Set the monthly data traffic limitation. The system will record the data traffic statistics when data traffic limitation (MiB) is specified. The traffic record will be displayed in Interface > Link Manager > Status > WWAN Data Usage Statistics . 0 means disable data traffic record.	0
Billing Day	Specify the monthly billing day. The data traffic statistics will be recalculated from that day.	1
Ping Detection Settings		
Enable	Click the toggle button to enable/disable the ping detection mechanism, a keep-alive policy of the router.	ON
Primary Server	Router will ping this primary address/domain name to check that if the current connectivity is active.	8.8.8.8
Secondary Server	Router will ping this secondary address/domain name to check that if the current connectivity is active.	114.114.114.114
Ping Interval	Set the ping interval.	300
Ping Retry Interval	Set the ping retry interval. When ping failed, the router will ping again every retry interval.	5
Ping Timeout	Set the ping timeout.	3
Max Ping Tries	Set the max ping tries. Switch to another link or take emergency action if the max continuous ping tries reached.	3
Advanced Settings		
NAT Enable	Click the toggle button to enable/disable the Network Address Translation option.	ON
Upload Bandwidth	Set the upload bandwidth used for QoS, measured in kbps.	10000
Download Bandwidth	Set the download bandwidth used for QoS, measured in kbps.	10000
Overridden Primary DNS	Override primary DNS will override the automatically obtained DNS.	Null
Overridden Secondary DNS	Override secondary DNS will override the automatically obtained DNS.	Null
Debug Enable	Click the toggle button to enable/disable this option. Enable for debugging information output.	ON

Link Settings (WWAN)		
Item	Description	Default
Verbose Debug Enable	Click the toggle button to enable/disable this option. Enable for verbose debugging information output.	OFF

WAN

Router will obtain IP automatically from DHCP server if choosing “DHCP” as connection type. The window is displayed as below.

Link Manager

^ **General Settings**

Index

Type

Description

Connection Type

The window is displayed as below when choosing “Static” as the connection type.

^ **General Settings**

Index

Type

Description

Connection Type

^ **Static Address Settings**

IP Address ?

Gateway

Primary DNS

Secondary DNS

The window is displayed as below when choosing “PPPoE” as the connection type.

^ General Settings

Index
 Type
 Description
Connection Type

^ WAN Settings

Data Allowance ?
 Billing Day ?

^ PPPoE Settings

Username
 Password
 Authentication Type
 PPP Expert Options ?

^ Ping Detection Settings ?

Enable ON OFF
 Primary Server
 Secondary Server
 Interval ?
 Retry Interval ?
 Timeout ?
 Max Ping Tries ?

^ Advanced Settings

NAT Enable ON OFF
 MTU
 Upload Bandwidth ?
 Download Bandwidth
 Overridden Primary DNS
 Overridden Secondary DNS
 Debug Enable ON OFF
 Verbose Debug Enable ON OFF

Link Settings (WAN)		
Item	Description	Default
General Settings		
Index	Indicate the ordinal of the list.	--
Type	Show the type of the link.	WAN
Description	Enter a description for this link. It can be null.	Null
Connection Type	Select from "DHCP", "Static" or "PPPoE".	DHCP
Static Address Settings		
IP Address	Set the IP address with Netmask which can access the internet. IP address with Netmask, e.g. 192.168.1.1/24	Null
Router	Set the router of the IP address in WAN port.	Null
Primary DNS	Set the primary DNS.	Null
Secondary DNS	Set the secondary DNS.	Null
PPPoE Settings		
Username	Enter the username provided by your Internet Service Provider.	Null
Password	Enter the password provided by your Internet Service Provider.	Null
Authentication Type	Select from "Auto", "PAP" or "CHAP" as the local ISP required.	Auto
PPP Expert Options	Enter the PPP Expert options used for PPPoE dialup. You can enter some other PPP dial strings in this field. Each string can be separated by a semicolon.	Null
WAN Settings		
Data Allowance	Set the monthly data traffic limitation. The system will record the data traffic statistics when data traffic limitation (MiB) is specified. The traffic record will be displayed in Interface > Link Manager > Status > WWAN Data Usage Statistics . 0 means disable data traffic record.	OFF
Billing Day	Specify the monthly billing day. The data traffic statistics will be recalculated from that day. If not set, traffic will not be counted.	1
Ping Detection Settings		
Enable	Click the toggle button to enable/disable the ping detection mechanism, a keep-alive policy of the router.	ON
Primary Server	Router will ping this primary address/domain name to check that if the current connectivity is active.	8.8.8.8
Secondary Server	Router will ping this secondary address/domain name to check that if the current connectivity is active.	114.114.1 14.114
Interval	Set the ping interval.	300
Retry Interval	Set the ping retry interval. When ping failed, the router will ping again every retry interval.	5
Timeout	Set the ping timeout.	3
Max Ping Tries	Set the max ping tries. Switch to another link or take emergency action if the max continuous ping tries reached.	3
Advanced Settings		
NAT Enable	Click the toggle button to enable/disable the Network Address Translation option.	ON
MTU	Enter the Maximum Transmission Unit.	1500

Upload Bandwidth	Enter the upload bandwidth used for QoS, measured in kbps.	10000
Download Bandwidth	Enter the download bandwidth used for QoS, measured in kbps.	10000
Overridden Primary DNS	Override primary DNS will override the automatically obtained DNS.	Null
Overridden Secondary DNS	Override secondary DNS will override the automatically obtained DNS.	Null
Debug Enable	Click the toggle button to enable/disable this option. Enable for debugging information output.	ON
Verbose Debug Enable	Click the toggle button to enable/disable this option. Enable for verbose debugging information output.	OFF

WLAN

Router will obtain IP automatically from the WLAN AP if choosing “DHCP” as the connection type. The specific parameter configuration of SSID is shown as below.

Link Manager

^ **General Settings**

Index

Type

Description

Connection Type

^ **WLAN Settings**

SSID

Connect to Hidden SSID OFF

Password

The window is displayed as below when choosing “Static” as the connection type.

^ **General Settings**

Index

Type

Description

Connection Type

v **WLAN Settings**

^ **Static Address Settings**

IP Address ?

Gateway

Primary DNS

Secondary DNS

R1520 does not support "PPPoE" WLAN connection types.

^ Ping Detection Settings
?

Enable ON OFF

Primary Server

Secondary Server

Interval ?

Retry Interval ?

Timeout ?

Max Ping Tries ?

^ Advanced Settings

NAT Enable ON OFF

MTU

Upload Bandwidth ?

Download Bandwidth

Overridden Primary DNS

Overridden Secondary DNS

Debug Enable ON OFF

Verbose Debug Enable ON OFF

Link Settings (WLAN)		
Item	Description	Default
General Settings		
Index	Indicate the ordinal of the list.	--
Type	Show the type of the link.	WLAN
Description	Enter a description for this link. It can be null.	Null
Connection Type	Select from "DHCP" or "Static".	DHCP
WLAN Settings		
SSID	Enter a 1-32 characters SSID which your router wants to connect. SSID (Service Set Identifier) is the name of your wireless network.	router
Connect to Hidden SSID	Click the toggle button to enable/disable this option. When router works as Client mode and needs to connect any access point which has hidden SSID, you need to enable this option.	OFF
Password	Enter an 8-63 characters password of the access point which your router wants to connect.	Null
Static Address Settings		
IP Address	Enter the IP address with Netmask which can access the Internet, e.g. 192.168.1.1/24	Null
Gateway	Enter the IP address of WiFi AP.	Null
Primary DNS	Set the primary DNS.	Null

Secondary DNS	Set the secondary DNS.	Null
Ping Detection Settings		
Enable	Click the toggle button to enable/disable the ping detection mechanism, a keepalive policy of the router.	ON
Primary Server	Router will ping this primary address/domain name to check that if the current connectivity is active.	8.8.8.8
Secondary Server	Router will ping this secondary address/domain name to check that if the current connectivity is active.	114.114.1 14.114
Interval	Set the ping interval.	300
Retry Interval	Set the ping retry interval. When ping failed, the router will ping again every retry interval.	5
Timeout	Set the ping timeout.	3
Max Ping Tries	Set the max ping tries. Switch to another link or take emergency action if the max continuous ping tries reached.	3
Advance Settings		
NAT Enable	Click the toggle button to enable/disable the Network Address Translation option.	ON
MTU	Enter the Maximum Transmission Unit.	1500
Upload Bandwidth	Enter the upload bandwidth used for QoS, measured in kbps.	10000
Download Bandwidth	Enter the download bandwidth used for QoS, measured in kbps.	10000
Overridden Primary DNS	Override primary DNS will override the automatically obtained DNS.	Null
Overridden Secondary DNS	Override secondary DNS will override the automatically obtained DNS.	Null
Debug Enable	Click the toggle button to enable/disable this option. Enable for debugging information output.	ON
Verbose Debug Enable	Click the toggle button to enable/disable this option. Enable for verbose debugging information output.	OFF

Status

This page allows you to view the status of link connection and clear the monthly data usage statistics.

Link Manager		Status		
^ Link Status				
Index	Link	Status	Uptime	IP Address
1	WWAN1	Connected	0 days, 01:03:29	10.122.74.11..
2	WWAN2	Disconnected		

Click the right-most button  to select the connection status of the current link.

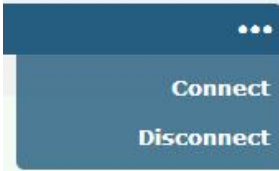

Click the row of the link, and it will show the details information of the current link connection under the row.

Link Manager
Status

^ Link Status
...

Index	Link	Status	Uptime	IP Address
1	WWAN1	Connected	0 days, 01:03:29	10.122.74.11..
Index 1 Link WWAN1 Status Connected Interface wwan Uptime 0 days, 01:03:29 IP Address 10.122.74.11/255.255.255.248 Gateway 10.122.74.9 DNS 210.21.4.130 221.5.88.88 RX Packets 42 TX Packets 46 RX Bytes 2962 TX Bytes 3568				
2	WWAN2	Disconnected		

^ WWAN Data Usage Statistics
?

WWAN1 Monthly Stats Clear

WWAN2 Monthly Stats Clear

^ WAN Data Usage Statistics
?

WAN Monthly Stats Clear

WWAN usage data statistics and WAN usage data statistics respectively count the packet flow of the cellular module and WAN.

Click the Clear button to clear the monthly data traffic usage statistics of SIM1 or SIM2. Data statistics will be displayed only if enable the Data Allowance function in **Interface > Link Manager > Link Settings > WWAN1/WWAN2/WAN Settings > Data Allowance** .

^ WWAN Settings

Automatic APN Selection ON OFF

Dialup Number

Authentication Type v

Switch SIM By Data Allowance ON OFF ?

Data Allowance ?

Billing Day ?

^ WAN Settings

Data Allowance ?

Billing Day ?

4.2.2 LAN

This section allows you to set the related parameters for LAN port. When ETH0 is configured as WAN, the router has four LAN ports, ETH1, ETH2, ETH3, and ETH4. The ETH1, ETH2, ETH3 and ETH4 can freely choose from lan0, lan1, lan2 and lan3. When ETH0 is configured as LAN, the router has five LAN ports, ETH0, ETH1, ETH2, ETH3, and ETH4. The ETH0, ETH1, ETH2, ETH3 and ETH4 can freely choose from lan0, lan1, lan2, lan3 or lan4. Whether it is four LAN ports or five LAN ports, lan0 must be selected by at least one LAN port. The default settings of ETH1/ETH2/ETH3/ETH4 are lan0 and their default IP are 192.168.0.1/255.255.255.0.

LAN

LAN	Multiple IP	Status		
^ Network Settings ?				
Index	Interface	IP Address	Netmask	
1	lan0	192.168.0.1	255.255.255.0	+ ✕

Note: Lan0 cannot be deleted.

You may click **+** to add a new LAN port, or click **✕** to delete the current LAN port. Now, click **✎** to edit the configuration of the LAN port.

LAN

^ General Settings

Index

Interface v

IP Address

Netmask

MTU

General Settings @ LAN		
Item	Description	Default
Index	Indicate the ordinal of the list.	--
Interface	Show the editing port. Note: Lan1 is available only if it was selected by one of ETH1~ETH4 in Ethernet > Ports > Port Settings .	lan0
IP Address	Set the IP address of the LAN port.	192.168.0.1
Netmask	Set the Netmask of the LAN port.	255.255.255.0
MTU	Enter the Maximum Transmission Unit.	1500

The window is displayed as below when choosing “Server” as the mode.

^ DHCP Settings

Enable ON OFF

Mode v

IP Pool Start

IP Pool End

Subnet Mask

^ DHCP Advanced Settings

Gateway

Primary DNS

Secondary DNS

WINS Server

Lease Time ?

Static lease ?

Expert Options ?

Debug Enable ON OFF

The window is displayed as below when choosing “Relay” as the mode.

^ DHCP Settings

Enable ON OFF

Mode v

DHCP Server For Relay



^ DHCP Advanced Settings



Debug Enable ON OFF

LAN

Item	Description	Default
DHCP Settings		
Enable	Click the toggle button to enable/disable the DHCP function.	ON
Mode	Select the mode of DHCP from “Server” or “Relay”. <ul style="list-style-type: none"> Server: Lease IP address to DHCP clients which have been connected to LAN port Relay: Router can be DHCP Relay, which will provide a relay tunnel to solve problem that DHCP Client and DHCP Server is not in a same subnet 	Server
IPv4 Pool Start	Define the beginning of the pool of IP addresses which will be leased to DHCP clients.	192.168.0.2
IPv4 Pool End	Define the end of the pool of IP addresses which will be leased to DHCP clients.	192.168.0.100
Subnet Mask	Define the subnet mask of IP address obtained by DHCP clients from DHCP server.	255.255.255.0
DHCP Server for Relay	Enter the IP address of DHCP relay server.	Null
DHCP Advanced Settings		
Router	Define the router assigned by the DHCP server to the clients, which must be on the same network segment with DHCP address pool.	Null
Primary DNS	Override primary DNS will override the automatically obtained DNS.	Null
Secondary DNS	Define the secondary DNS server assigned by the DHCP server to the Override secondary DNS will override the automatically obtained DNS.	Null
WINS Server	Define the Windows Internet Naming Service obtained by DHCP clients from DHCP sever.	Null
Lease Time	Set the lease time which the client can use the IP address obtained from DHCP server, measured in seconds.	120
Static lease	Bind a lease to correspond an IP address via a MAC address. format: mac,ip;mac,ip;..., e.g. FF:ED:CB:A0:98:01,192.168.0.200	Null
Expert Options	Enter some other options of DHCP server in this field. format: config-desc;config-desc, e.g. log-dhcp;quiet-dhcp	Null
Debug Enable	Click the toggle button to enable/disable this option. Enable for DHCP information output.	OFF

Multiple IP

LAN	Multiple IP	Status		
^ Multiple IP Settings				
Index	Interface	IP Address	Netmask	
1	lan0	10.0.0.1	255.255.255.0	 

You may click  to edit the multiple IP of the LAN port, or click  to delete the multiple IP of the LAN port. Now, click  to add a new multiple IP of the LAN port.

Multiple IP

^ IP Settings

Index	<input type="text" value="1"/>
Interface	<input style="border: 1px solid #ccc;" type="text" value="lan0"/> v
IP Address	<input type="text" value="10.0.0.1"/>
Netmask	<input type="text" value="255.255.255.0"/>

IP Settings		
Item	Description	Default
Index	Indicate the ordinal of the list.	--
Interface	Show the editing port, read only.	--
IP Address	Set the multiple IP address of the LAN port.	Null
Netmask	Set the multiple Netmask of the LAN port.	Null

Status

This section allows you to view the status of LAN connection.

LAN
Multiple IP
Status

^ Interface Status

Index	Interface	IP Address	MAC Address
1	lan0	192.168.0.1/255.2...	34:FA:40:0B:68:AC

^ Connected Devices

Index	IP Address	MAC Address	Interface	Inactive Time
1	192.168.0.5	D4:3A:65:05:FC:4A	lan0	0s

^ DHCP Lease Table

Index	IP Address	MAC Address	Interface	Expired Time
1	192.168.0.5	d4:3a:65:05:fc:4a	lan0	0 days, 01:51:32

Click the row of status, the details status information will be display under the row.

^ Interface Status

Index	Interface	IP Address	MAC Address
1	lan0	192.168.0.1/255.2...	34:FA:40:0B:68:AC

Index 1

Interface lan0

IP Address 192.168.0.1/255.255.255.0

MAC Address 34:FA:40:0B:68:AC

RX Packets 14470

TX Packets 12759

RX Bytes 2849614

TX Bytes 10657230

4.2.3 Ethernet

This section allows you to set the related parameters for Ethernet. There are five Ethernet ports on R1520 Router, including ETH0, ETH1, ETH2, ETH3 and ETH4 . ETH0 can be configured as the WAN port for the router to access the outer network or the LAN port for the lower end devices to connect with the router. ETH1, ETH2, ETH3 and ETH4 can only be configured as a LAN port for the lower device to connect to the router. The default factory settings of ETH0 is Wan. ETH1, ETH2, ETH3 and ETH4 are lan0, and the default IP is 192.168.0.1/255.255.255.0.

Ports		Status
^ Port Settings		
Index	Port	Port Assignment
1	eth0	wan
2	eth1	lan0
3	eth2	lan0
4	eth3	lan0
5	eth4	lan0

Click the button on the right-most of eth1 to change the port parameters in the port window that pops up.

Ports

^ Port Settings

Index:

Port:

Port Assignment:

Ports

^ Port Settings

Index:

Port:

Port Assignment:

lan0
lan1
lan2
lan3
lan4
wan

Submit Close

Port Settings		
Item	Description	Default
Index	Indicate the ordinal of the list.	--
Port	Show the editing port, read only.	--
Port Assignment	Choose the Ethernet port's type, as a WAN port or a LAN port. When setting the port as a LAN port in Interface > LAN > LAN > Network Settings > General Settings , you can click the drop-down list to select from "lan0", "lan1", "lan2" or "lan3"	lan0

Click the status column to view the connection status of all Ethernet ports.

Ports		Status
^ Port Status		
Index	Port	Link
1	eth0	Down
2	eth1	Up
3	eth2	Down
4	eth3	Down
5	eth4	Down

Click the row of status, the details status information will be display under the row. Please refer to the screenshot below.

Ports		Status
^ Port Status		
Index	Port	Link
1	eth0	Down
2	eth1	Up
		Index 2 Port eth1 Link Up
3	eth2	Down
4	eth3	Down
5	eth4	Down

4.2.4 Cellular

This section allows you to set the related parameters of Cellular. The R1520 Router has two SIM card slot. When inserting a single SIM card for the first time, both Sim1 and sim2 slots are available.

Cellular		Status	AT Debug
^ Advanced Cellular Settings			
Index	SIM Card	Phone Number	Network Type
1	SIM1		Auto
2	SIM2		Auto

Click the right most button of SIM 1 to edit the parameters.

Cellular

^ General Settings

Index:

SIM Card: v

Phone Number:

PIN Code: ?

Extra AT Cmd: ?

Telnet Port: ?

The window is displayed as below when choosing “Auto” as the network type.

^ Cellular Network Settings

Network Type v ?

Band Select Type v ?

^ Advanced Settings

Debug Enable ON OFF

Verbose Debug Enable ON OFF

The window is displayed as below when choosing “Specify” as the band select type.

^ Cellular Network Settings

Network Type v ?

Band Select Type v ?

^ Band Settings

GSM 850	<input type="checkbox"/> ON <input checked="" type="checkbox"/> OFF
GSM 900	<input type="checkbox"/> ON <input checked="" type="checkbox"/> OFF
GSM 1800	<input type="checkbox"/> ON <input checked="" type="checkbox"/> OFF
GSM 1900	<input type="checkbox"/> ON <input checked="" type="checkbox"/> OFF
WCDMA 800	<input type="checkbox"/> ON <input checked="" type="checkbox"/> OFF
WCDMA 850	<input type="checkbox"/> ON <input checked="" type="checkbox"/> OFF
WCDMA 900	<input type="checkbox"/> ON <input checked="" type="checkbox"/> OFF
WCDMA 1900	<input type="checkbox"/> ON <input checked="" type="checkbox"/> OFF
WCDMA 2100	<input type="checkbox"/> ON <input checked="" type="checkbox"/> OFF
WCDMA 1700	<input type="checkbox"/> ON <input checked="" type="checkbox"/> OFF
LTE Band 1	<input type="checkbox"/> ON <input checked="" type="checkbox"/> OFF
LTE Band 3	<input type="checkbox"/> ON <input checked="" type="checkbox"/> OFF
LTE Band 5	<input type="checkbox"/> ON <input checked="" type="checkbox"/> OFF
LTE Band 7	<input type="checkbox"/> ON <input checked="" type="checkbox"/> OFF
LTE Band 8	<input type="checkbox"/> ON <input checked="" type="checkbox"/> OFF
LTE Band 20	<input type="checkbox"/> ON <input checked="" type="checkbox"/> OFF

^ Advanced Settings

Debug Enable ON OFF

Verbose Debug Enable ON OFF

Cellular		
Item	Description	Default
General Settings		
Index	Indicate the ordinal of the list.	--
SIM Card	Set the currently editing SIM card.	SIM1
Phone Number	Enter the phone number of the SIM card.	Null
PIN Code	Enter a 4-8 characters PIN code used for unlocking the SIM.	Null
Extra AT Cmd	Enter the AT commands used for cellular initialization.	Null
Telnet Port	Specify the Port listening of telnet service, used for AT over Telnet.	0
Cellular Network Settings		
Network Type	Select from "Auto", "4G Only", "4G First". <ul style="list-style-type: none"> Auto: Connect to the best signal network automatically 4G Only: Only the 4G network is connected 4G First: Connect to the 4G Network preferentially 	Auto
Band Select Type	Select from "All" or "Specify". You may choose certain bands if choosing "Specify".	All
Advanced Settings		
Debug Enable	Click the toggle button to enable/disable this option. Enable for debugging information output.	ON
Verbose Debug Enable	Click the toggle button to enable/disable this option. Enable for verbose debugging information output.	OFF

This section allows you to view the status of the cellular connection.

Cellular				
Status				
^ Status				
Index	Modem Status	Modem Model	IMSI	Registration
1	Ready	EC20F	460019372994937	Registered to home network

Click the row of status, the details status information will be displayed under the row.

^ Status				
Index	Modem Status	Modem Model	IMSI	Registration
1	Ready	EC20F	460019372994937	Registered to home network
Index 1				
Modem Status Ready				
Modem Model EC20F				
Current SIM SIM1				
Phone Number				
IMSI 460019372994937				
ICCID 89860118801079009362				
Registration Registered to home network				
Network Provider CHN-UNICOM				
Network Type LTE				
Band 3				
Signal Strength 19 (-75dBm)				
RSRP -107 dBm				
RSRQ -7 dB				
SINR 21 dB				
Bit Error Rate 99				
PLMN ID 46001				
Local Area Code 2507				
Cell ID 6074702				
IMEI 862107045897238				
Firmware Version EC20CEFAGR06A09M4G				

Status	
Item	Description
Index	Indicate the ordinal of the list.
Modem Status	Show the status of the radio module.
Modem Model	Show the model of the radio module.
Current SIM	Show the SIM card that your router is using: SIM1 or SIM2.
Phone Number	Show the phone number of the current SIM. Note: This option will be displayed if enter manually in Cellular > Advanced Cellular Settings > SIM1 > General Settings > Phone Number .
IMSI	Show the IMSI number of the current SIM.
ICCID	Show the ICCID number of the current SIM.
Registration	Show the current network status.
Network Provider	Show the name of Network Provider.
Network Type	Show the current network service type, e.g. GPRS.

Status	
Item	Description
Band	Show the band of the current network.
Signal Strength	Show the signal strength.
RSRP	Show the Reference Signal Received Power. (Only valid for 4G network)
RSRQ	Show the Reference Signal Received Quality. (Only valid for 4G network)
SINR	Show the Signal to Interference plus Noise Ratio. (Only valid for 4G network)
EC/IO	Show EC/IO when registering to 3G networks.
Bit Error Rate	Show the current bit error rate.
PLMN ID	Show the current PLMN ID.
Local Area Code	Show the current local area code used for identifying different area.
Community ID	Show the current Community ID used for locating the router.
IMEI	Show the IMEI (International Mobile Equipment Identity) number of the radio module.
Firmware Version	Show the current firmware version of the radio module.

Click the "AT Debug" to detect the AT command.

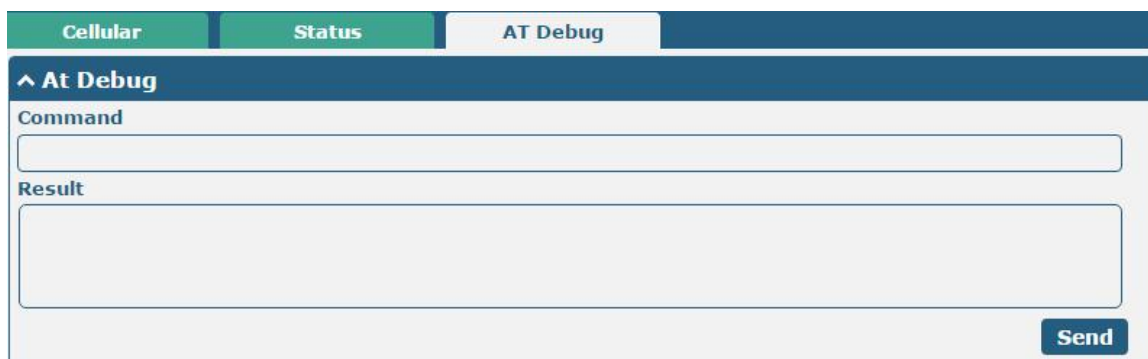

AT Debug		
Item	Description	Default
Command	Enter the AT command that you want to send to cellular module in this text box.	Null
Result	Show the AT command responded by cellular module in this text box.	Null
	Click the button to send AT command.	--

4.2.5 WiFi

This section allows you to configure the parameters of WiFi AP and WiFi Client. Router supports either WiFi AP mode or Client mode, and defaults as AP.

WiFi AP

Configure Router as WiFi AP

Click **Interface > WiFi > WiFi**, select “AP” as the mode and click “Submit”.



WiFi	Access Point	Advanced	ACL	Status
^ General Settings				
	Mode	AP	v	?
	Region	SE		?

Note: Please remember to click **Save & Apply** after finish the configuration, so that the configuration can be took effect.

Click the **Access Point** column to configure the parameters of WiFi AP. By default, the security mode is set as “Disabled”.



WiFi	Access Point	Advanced	ACL	Status
^ General Settings				
	Enable	ON	OFF	
	Wireless Mode	11bgn Mixed	v	
	Channel	Auto	v	?
	SSID	router		
	Broadcast SSID	ON	OFF	
	Security Mode	Disabled	v	?

The window is displayed as below when setting “WPA-Personal” as the security mode.

The screenshot shows the 'Advanced' tab of the WiFi configuration interface. The 'General Settings' section is expanded. The 'Security Mode' dropdown menu is highlighted with a red box and is set to 'WPA-Personal'. Other visible settings include 'Enable' (ON), 'Wireless Mode' (11bgn Mixed), 'Channel' (Auto), 'SSID' (router), 'Broadcast SSID' (ON), 'WPA Version' (Auto), 'Encryption' (Auto), 'PSK Password' (empty), and 'Group Key Update Interval' (3600).

The window is displayed as below when setting “WPA-Enterprise” as the security mode.

The screenshot shows the 'Advanced' tab of the WiFi configuration interface. The 'General Settings' section is expanded. The 'Security Mode' dropdown menu is highlighted with a red box and is set to 'WPA-Enterprise'. Other visible settings include 'Enable' (ON), 'Wireless Mode' (11bgn Mixed), 'Channel' (Auto), 'SSID' (router), 'Broadcast SSID' (ON), 'WPA Version' (Auto), 'Encryption' (Auto), 'Radius Authentication Server Address' (empty), 'Radius Authentication Server Port' (1812), 'Radius Server Share Secret' (empty), and 'Group Key Update Interval' (3600).

The window is displayed as below when setting “WEP” as the security mode.



General Settings @ Access Point 2G		
Item	Description	Default
Enable	Click the toggle button to enable/disable the WiFi access point option.	OFF
Wireless Mode	<p>Select from “11bgn Mixed”, “11b only”, “11g only” and “11n only”.</p> <ul style="list-style-type: none"> 11bgn Mixed: mix three protocols for backward compatibility 11b only: IEEE 802.11b, 11 Mbps~2.4GHz 11g only: IEEE 802.11g, 54 Mbps~2.4GHz 11n only: IEEE 802.11n, 300 Mbps 	11bgn Mixed
Channel	<p>The channel that different bandwidth can choose is as follows.</p> <ul style="list-style-type: none"> Auto: Router will scan all frequency channels until the best one is found 1~13 channel of 20MHz bandwidth will be fixed to work with this channel: <ul style="list-style-type: none"> 1–2412 MHz 2–2417 MHz 3–2422 MHz 4–2427 MHz 5–2432 MHz 6–2437 MHz 7–2442 MHz 8–2447 MHz 9–2452 MHz 10–2457 MHz 11–2462 MHz 12–2467 MHz 13–2472 MHz The frequency of 3~11 channels of 40MHz bandwidth available channel: 	Auto

General Settings @ Access Point 2G		
Item	Description	Default
	1–2412 MHz 2–2417 MHz 3–2422 MHz 4–2427 MHz 5–2432 MHz 6–2437 MHz 7–2442 MHz 8–2447 MHz 9–2452 MHz 10–2457 MHz 11–2462 MHz 12–2467 MHz 13–2472 MHz	
SSID	Enter the Service Set Identifier, the name of your wireless network. The SSID of a client and the SSID of the AP must be identical for the client and AP to be able to communicate with each other. Enter 1 to 32 characters.	router
Broadcast SSID	Click the toggle button to enable/disable the SSID being broadcast. When enabled, the client can scan your SSID. When disabled, the client cannot scan your SSID. If you want to connect to the router AP, you need to manually enter the SSID of router AP at WiFi client side.	ON
Security Mode	Select from “Disabled”, “WPA-Personal”, “WPA-Enterprise” or “WEP”. <ul style="list-style-type: none"> • Disabled: User can access the WiFi without password Note: It is strongly recommended for security purposes that you do not choose this kind of mode. • WPA-personal: WiFi access protection, only one password is provided for identity authentication • WPA-Enterprise: Supports 802.1x RADIUS authentication. • WEP: Wired Equivalent Privacy provides encryption for wireless device’s data transmission 	Disabled
WPA Version	Select from “Auto”, “WPA” or “WPA2”. <ul style="list-style-type: none"> • Auto: Router will choose automatically the most suitable WPA version • WPA2 is a stronger security feature than WPA 	Auto
Encryption	Select from “TKIP” or “AES”. <ul style="list-style-type: none"> • TKIP: Temporal Key Integrity Protocol (TKIP) encryption uses a wireless connection. TKIP 	AES

General Settings @ Access Point 2G		
Item	Description	Default
	<p>encryption can be used for WPA-PSK and WPA 802.1x authentication</p> <ul style="list-style-type: none"> AES: AES encryption uses a wireless connection. AES can be used for CCMP WPA-PSK and WPA 802.1x authentication. AES is a stronger encryption algorithm than TKIP <p>Note: The security mode will affect wireless communication rate. Different wireless modes support different encryption modes. For example, 802.11n supports neither WEP security mode nor TKIP algorithm. If they are used, the wireless communication rate will reduce to 54Mbps (802.11g mode). It is recommended to select AES in 802.11n mode.</p>	
PSK Password	Enter the Pre share key password. Enter 8 to 63 characters.	Null
Radius Authentication Server Address	Enter the IP address of the Radius authentication server.	Null
Radius Authentication Server Port	Enter the port of the Radius authentication server.	1812
Radius Server Share Secret	Enter Radius to identify the server's Shared key.	Null
Group Key Update Interval	Enter the time period of group key renewal.	3600
WEP Key	Enter the WEP key. The key length should be 10 or 26 hexadecimal digits depending on which WEP key is used, 64 digits or 128 digits.	Null

^ Advanced Settings

Max Associated Stations	<input type="text" value="64"/>	
Beacon Interval	<input type="text" value="100"/>	?
DTIM Period	<input type="text" value="2"/>	?
RTS Threshold	<input type="text" value="2347"/>	?
Fragmentation Threshold	<input type="text" value="2346"/>	?
Transmit Rate	<input type="text" value="Auto"/>	v
11N Transmit Rate	<input type="text" value="Auto"/>	v
Transmit Power	<input type="text" value="Max"/>	v
Channel Width	<input type="text" value="Auto"/>	v ?
Enable Short GI	<input checked="" type="checkbox"/> ON <input type="checkbox"/> OFF	?
Enable AP Isolation	<input type="checkbox"/> ON <input checked="" type="checkbox"/> OFF	?
Debug Level	<input type="text" value="none"/>	v

Advanced Settings @ Access Point		
Item	Description	Default
Max Associated Stations	Set the max number of clients allowed to access the router's AP. (0 value means no limit)	0
Beacon Interval	Set the interval of time in which the router AP broadcasts a beacon which is used for wireless network authentication.	100
DTIM Period	Set the delivery traffic indication message period and the router AP will multicast the data according to this period.	2
RTS/CTS Threshold	Set the threshold of "request to send", which is the request to send a threshold. When the threshold set as 2347, the router AP will not send detection signal before sending data. And when the threshold set as 0, the router AP will send detection signal before sending data.	2347
Fragmentation Threshold	Set the fragmentation threshold of a WiFi AP. It is recommended that you use the default value 2346.	2346
Transmit Rate	Specify the data transfer rate or default to automatic.	Auto
11N Transmit Rate	Specify the data transfer rate in IEEE 802.11n WiFi mode or default to automatic.	Auto
Transmit Power	Select the transmit power level. Select from "Max", "High", "Medium" or "Low".	Max
bandwidth	Select from "20MHz" or "40MHz". Note: The 40MHz channel bandwidth provides an available data transfer rate that is more than twice that of a single 20MHz channel.	20MHZ
Enable Short GI	Click the toggle button to enable/disable the Short Guard Interval option. Short GI is a blank time between two symbols, providing a long buffer time for signal delay. Using the Short GI would increase 11% in data rates, but also result in higher packet error rates.	ON
Enable AP Isolation	Click the toggle button to enable/disable the AP isolation option. When enabled, the router will isolate all connected wireless devices. The wireless device cannot access the router directly via WLAN.	OFF
Debug Level	Select from "verbose", "deBug", "info", "notice", "warning" or "none".	none

^ General Settings

Enable ACL OFF

ACL Mode v ?

^ Access Control List

Index	Description	MAC Address
+		

Click **+** to add a MAC address to the Access Control List. The maximum count for MAC address is 64.

ACL

^ **Access Control List**

Index

Description

MAC Address

ACL Settings @ Access Point		
Item	Description	Default
Enable ACL	Click the toggle button to enable/disable this option.	OFF
ACL Mode	Select ACL mode. Select from "Accept" or "Deny". <ul style="list-style-type: none"> Accept: Only the packets fitting the entities of the "Access Control List" can be allowed Deny: All the packets fitting the entities of the "Access Control List" will be denied Note: Router can only allow or deny devices which are included in "Access Control List" at one time.	Accept
Access Control List @ Access Point		
Index	Indicate the ordinal of the list.	--
Description	Enter a description for this access control list.	Null
MAC Address	Add a MAC address here.	Null

This section allows you to view the status of AP.

WiFi
Access Point
Advanced
ACL
Status

^ **AP Status**

Status COMPLETED

Channel 1

Channel Width 20 MHz

MAC Address 34:FA:40:09:D3:38

^ **Associated Stations**

Index	MAC Address	IP Address	Name	Connected Time	Signal

Note: WiFi is off by default. Follow the steps below to enable it and configure the router as WiFi client.

WiFi Client

Configure Router as WiFi Client

Click **Interface > WiFi > WiFi**, select “Client” as the mode and regarding the AP type to choose the related Client Band then click “Submit”.

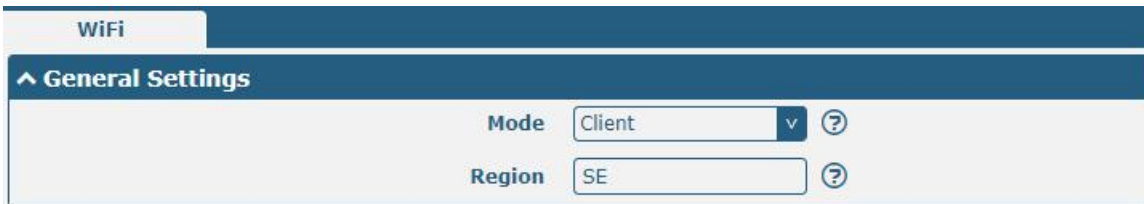

The screenshot shows the WiFi configuration page. The 'General Settings' section is expanded, showing the 'Mode' dropdown menu set to 'Client' and the 'Region' dropdown menu set to 'SE'. There are help icons (question marks) next to both dropdowns.

And then a “WLAN” column will appear under the Interface list.



The screenshot shows the WiFi configuration page with the 'Interface' list on the left. The 'WLAN' column is highlighted in red. The 'General Settings' section is expanded, showing the 'Mode' dropdown menu set to 'Client' and the 'Region' dropdown menu set to 'SE'.

Click **Interface > Link Manager > Link Settings**, and click the edit button of WLAN, then configure its related parameters.



The screenshot shows the WLAN Settings page. The 'SSID' field is set to 'router'. The 'Connect to Hidden SSID' toggle is set to 'OFF'. The 'Password' field is empty.

Click **Interface > WLAN** to configure the parameters of WiFi Client after setting the mode as Client.

Status

^ WLAN Status

Status	Connected
Uptime	0 days, 00:02:40
IP Address	172.16.23.246/255.255.255.0
Gateway	172.16.23.1
DNS	172.16.23.2 114.114.114.114
MAC Address	34:fa:40:09:d3:38

^ Link Status

Signal	-74 dBm
Noise	-95 dBm
Width	20 MHz
TX Bitrate	1.0 MBit/s
TX	2034 bytes (26 packets)
RX	662881 bytes (4446 packets)

^ WPA Status

WPA State	COMPLETED
Frequency	2412
BSSID	20:65:8e:ba:56:60
SSID	Robustel
Mode	station
Key Management	WPA2-PSK
Pairwise Cipher	CCMP
Group Cipher	TKIP

Users can refresh the SSID scan results near the router. Click , and then click scan to refresh the surrounding SSID

^ Scan Results ... ?

Index	SSID	MAC Address	Frequency	Signal	
1	Robustel-Visitor	20:65:8E:BA:56:61	2412	-72 dBm	
2	DIRECT-mE-mix2s	C2:4C:2C:EB:0C:90	2412	-74 dBm	
3	Robustel	20:65:8E:BA:56:60	2412	-75 dBm	
4	router-203	00:23:A7:AB:64:F4	2422	-83 dBm	
5	OpenWrt	B8:27:EB:B6:C8:75	2462	-89 dBm	

4.2.6 USB

This section allows you to configure the USB parameters. The router's USB interface can be used to upgrade firmware

and upgrade configuration.



General Settings @ USB		
Item	Description	Default
Enable USB	Click the toggle button to enable/disable the USB option.	ON
Enable Automatic Upgrade	Click the toggle button to enable/disable this option. Enable to automatically update the firmware of the router when inserting a USB storage device with a router firmware.	OFF
Key		
Item	Description	Default
USB Automatic Update Key	Click Generate to generate a key, and click Download to download the key.	--

Note: when using the USB automatic upgrade function, the LEDs start blinking one by one, it means that the upgrade is in progress. When LEDs stop blinking one by one, and the USER Indicators is on, it means that the upgrade is completed. After upgrading, the device will not restart automatically. If there is no LEDs start blinking one by one all the time, it means there is an exception, and it does not enter into the automatic upgrade process.

4.2.7 DI/DO

This section allows you to set the DI/DO parameters. Digital Input and Digital Output are the specific interfaces for R1520. The DI interface can be used for triggering alarm, while the DO can be used for controlling the slave device so as to realize real-time monitoring.

DI

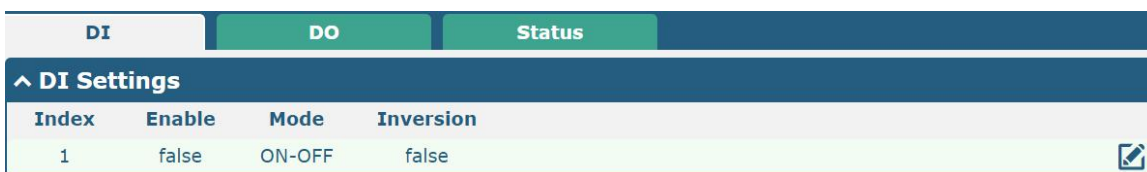

Click the right-most button of DI index 1 as below. The window is displayed as below when the default mode is "ON-OFF".

DI

^ General Settings

Index

Enable ON OFF

Mode v

Inversion ON OFF

Alarm On Content

Alarm Off Content

The window is displayed as below when choosing “Counter” as the mode.

DI

^ General Settings

Index

Enable ON OFF

Mode v

Inversion ON OFF

Threshold Value

Alarm On Content

Alarm Off Content

General Settings @ DI		
Item	Description	Default
Index	Indicate the ordinal of the list.	--
Enable	Click the toggle button to enable/disable the digital input function.	OFF
Mode	Select from “ON-OFF” or “Counter”. <ul style="list-style-type: none"> ON-OFF: Alarm mode can be triggered at the DI access ON-OFF. Counter: Event counter mode 	ON-OFF
Inversion	The count is divided into a rising edge count of the level or a falling edge count. If the current rising edge count, the reverse edge is the falling edge count.	OFF
Threshold Value	The threshold value is a unique parameter when the mode is count. Set the threshold value to trigger the DI alarm when the count value reaches the threshold value.	0
Alarm On Content	Show the content when alarm on.	Alarm On
Alarm Off Content	Show the content when alarm off.	Alarm Off

Note: It defaults as high alarm, while turns to low alarm after enabling the “Inversion” button.

DO

DI	DO	Status			
^ DO Settings					
Index	Enable	Alarm On Action	Alarm Off Action	Initial State	Alarm Source
1	false	High	Low	Last	DI1 Alarm

Click to enter the DO index 1, the configuration window is shown as below.

DO

^ General Settings

Index

Enable ON OFF

Alarm On Action v

Alarm Off Action v

Initial State v

Delay ?

Hold Time ?

Alarm Source v

The window is displayed as below when choosing “Pulse” as the alarm on action.

DO

^ General Settings

Index

Enable ON OFF

Alarm On Action v

Alarm Off Action v

Initial State v

Delay ?

Hold Time ?

Low-level Width ?

High-level Width ?

Alarm Source v

The window is displayed as below when choosing “Pulse” as the alarm off action.

DO

^ **General Settings**

Index

Enable ON OFF

Alarm On Action v

Alarm Off Action v

Initial State v

Delay ?

Hold Time ?

Low-level Width ?

High-level Width ?

Alarm Source v

General Settings @ DO		
Item	Description	Default
Index	Indicate the ordinal of the list.	--
Enable	Click the toggle button to enable/disable this DO.	OFF
Alarm On Action	Digital Output initiates when there is an alarm. Selected from “High”, “Low” or “Pulse”. <ul style="list-style-type: none"> High: a high electrical level output Low: a low electrical level output Pulse: Generates a square wave as specified in the pulse mode parameters when triggered 	High
Alarm Off Action	Digital Output initiates when alarm removed. Selected from “High”, “Low” or “Pulse”. <ul style="list-style-type: none"> High: a high electrical level output Low: a low electrical level output Pulse: Generates a square wave as specified in the pulse mode parameters when triggered 	Low
Initial State	Specify the Digital Output status when powered on. Selected from “Last”, “High” or “Low”. <ul style="list-style-type: none"> Last: DO’s status will consist with the status of last power off High: DO interface is in high electrical level Low: DO interface is in low electrical level 	Last
Delay (unit: 100ms)	Set the delay time for DO alarm start-up. The first pulse will be generated after a “Delay”. Enter from 0 to 3000 (0=generate pulse without delay).	0
Hold Time (unit: s)	Set the hold time of DO status (Alarm On Action/Alarm Off Action). When the action time reach this specified time, DO will stop the action. Enter from 0 to 3000 seconds. (0=keep on until the next action)	0
Low-level Width	Set the low-level width. It is available when enabling Pulse as “Alarm On Action/Alarm	1000

General Settings @ DO		
Item	Description	Default
(unit: ms)	Off Action". In Pulse Output mode, the selected digital output channel will generate a square wave as specified in the pulse mode parameters. The low level widths are specified here. Enter from 1000 to 3000.	
High-level Width (unit: ms)	Set the high-level width. It is available when enabling Pulse as "Alarm On Action/Alarm Off Action". In Pulse Output mode, the selected digital output channel will generate a square wave as specified in the pulse mode parameters. The high level widths are specified here. Enter from 1000 to 3000.	1000
Alarm Source	Digital output activation can be activated by this alarm.	DI1

Status

This window allows you to view the status of DI/DO interface. It can also clear the counter alarm of DI in here. Click **Clear** button to clear DI 1 or DI 2 monthly usage statistics info for counter alarm.

DI
DO
Status

^ DI Status

Index	Level	Status	Count
1	Low	Alarm off	

^ Action Of Clear

Counter Alarm Of DI 1
Clear

^ DO Status

Index	Level	Low-level Width	High-level Width
1	Low		

^ DO Control

Level Of DO1
Toggle

4.2.8 AI

This section is used to set the parameters of analog input (AI). AI is a unique interface of R1520 router. The analog input is used to collect analog signals within a certain range, and is often used to collect continuously changing values such as voltage, current, temperature, and pressure of the sensor. The higher the accuracy of the ADC bits used for analog input, the finer the analog quantization and the more accurate the result.

AI
Status

^ AI Settings

Index	Enable	Input Type	Interval
1	false	Voltage	5

✎

Click the right-most button of DI index 1 as below. The window is displayed as below when the "input type" is "voltage".

AI

^ **General Settings**

Index

Enable ON OFF

Input Type Voltage v ?

Min Threshold ?

Max Threshold ?

Interval ?

The window is displayed as below when the “input type” is “Current”.

AI

^ **General Settings**

Index

Enable ON OFF

Input Type Current v ?

Min Threshold ?

Max Threshold ?

Interval ?

AI (Analog Input)		
Item	Description	Default
Index	Indicate the ordinal of the list.	--
Enable	Click the switch button to "ON" to turn on the analog input function.	OFF
Input type	Select from "Voltage" or "Current". <ul style="list-style-type: none"> Voltage: The data collected is voltage Current: The data collected is Current 	Voltage
Min Threshold@Voltage	Set the minimum voltage threshold. When the voltage collected by the AI interface is less than the minimum voltage threshold, an event notification will be triggered. Unit: V.	3
Max Threshold@Voltage	Set the maximum voltage threshold. When the voltage collected by the AI interface is greater than the minimum voltage threshold, an event notification will be triggered. Unit: V.	20
Min Threshold@Current	Set the minimum current threshold. When the current collected by the AI interface is less than the minimum voltage threshold, an event notification will be triggered. Unit: mA.	4

AI (Analog Input)		
Item	Description	Default
Min Threshold@Current	Set the maximum current threshold. When the current collected by the AI interface is greater than the minimum voltage threshold, an event notification will be triggered. Unit: mA.	16
Interval	Collect the latest data every few seconds.	5

Click the "Status" column to view the status of the AI.

AI
Status

^ AI Status

Index	Type	Min Threshold	Max Threshold	Value
1	voltage	3	20	

Index 1

Type voltage

Min Threshold 3

Max Threshold 20

4.2.9 Serial Port

This section allows you to set the serial port parameters. The R1520 router supports two serial ports, COM1 and COM2. It can also be modified according to requirements and configured as two COM1 or two COM2. The serial data can be converted into IP data or through IP data into serial data, and then the data can be transmitted through wired or wireless network, so as to realize the function of transparent data transmission.

Serial Port
Status

^ Serial Port Settings

Index	Port	Enable	Baud Rate	Application Mode	
1	COM1	false	115200	Transparent	
2	COM2	false	115200	Transparent	

Click the right-most button of COM1 as below.

Serial Port

^ **Serial Port Application Settings**

Index	<input type="text" value="1"/>
Port	<input style="border-bottom: 1px solid #ccc;" type="text" value="COM1"/> v
Enable	<input type="checkbox"/> ON <input checked="" type="checkbox"/> OFF
Baud Rate	<input style="border-bottom: 1px solid #ccc;" type="text" value="115200"/> v
Data Bits	<input style="border-bottom: 1px solid #ccc;" type="text" value="8"/> v
Stop Bits	<input style="border-bottom: 1px solid #ccc;" type="text" value="1"/> v
Parity	<input style="border-bottom: 1px solid #ccc;" type="text" value="None"/> v
Flow Control	<input style="border-bottom: 1px solid #ccc;" type="text" value="None"/> v

^ **Data Packing**

Packing Timeout	<input type="text" value="50"/> ?
Packing Length	<input type="text" value="1200"/>

In the "Server Settings" column, when "Transparent " is selected as the application mode and "TCP Client" as the protocol, the window is as follows:

^ **Server Setting**

Application Mode	<input style="border-bottom: 1px solid #ccc;" type="text" value="Transparent"/> v
Protocol	<input style="border-bottom: 1px solid #ccc;" type="text" value="TCP Client"/> v
Server Address	<input type="text"/>
Server Port	<input type="text"/>

When "Transparent " is selected as the application mode and "TCP Server" as the protocol, the window is as follows:

^ **Server Setting**

Application Mode	<input style="border-bottom: 1px solid #ccc;" type="text" value="Transparent"/> v
Protocol	<input style="border-bottom: 1px solid #ccc;" type="text" value="TCP Server"/> v
Local IP	<input type="text"/>
Local Port	<input type="text"/>

When "Transparent " is selected as the application mode and "UDP" is used as the protocol, the window is as follows:

^ **Server Setting**

Application Mode	<input style="border-bottom: 1px solid #ccc;" type="text" value="Transparent"/> v
Protocol	<input style="border-bottom: 1px solid #ccc;" type="text" value="UDP"/> v
Local IP	<input type="text"/>
Local Port	<input type="text"/>
Server Address	<input type="text"/>
Server Port	<input type="text"/>

When “ModBus RTU Gateway” is selected as the application mode and “TCP Client” as the protocol, the window is as follows:

^ Server Setting

Application Mode	Modbus RTU Gateway v
Protocol	TCP Client v
Server Address	<input type="text"/>
Server Port	<input type="text"/>

When "ModBus RTU Gateway" is selected as the application mode and "TCP Server" as the protocol, the window is as follows:

^ Server Setting

Application Mode	Modbus RTU Gateway v
Protocol	TCP Server v
Local IP	<input type="text"/>
Local Port	<input type="text"/>

When selecting "ModBus RTU Gateway" as the application mode and "UDP" as the protocol, the window is as follows:

^ Server Setting

Application Mode	Modbus RTU Gateway v
Protocol	UDP v
Local IP	<input type="text"/>
Local Port	<input type="text"/>
Server Address	<input type="text"/>
Server Port	<input type="text"/>

When “ModBus ASCII Gateway” is selected as the application mode and “TCP Client” as the protocol, the window is as follows:

^ Server Setting

Application Mode	Modbus ASCII Gateway v
Protocol	TCP Client v
Server Address	<input type="text"/>
Server Port	<input type="text"/>

When selecting "ModBus ASCII Gateway" as the application mode and "TCP Server" as the protocol, the window is as follows:

^ Server Setting

Application Mode

Protocol

Local IP

Local Port

When selecting "ModBus ASCII Gateway" as the application mode and "UDP" as the protocol, the window is as follows:

^ Server Setting

Application Mode

Protocol

Local IP

Local Port

Server Address

Server Port

Serial Port		
Item	Description	Default
Serial Port Application Settings		
Index	Indicate the ordinal of the list.	--
Port	Show the current serial's name, read only.	COM1
Enable	Click the toggle button to enable/disable this serial port. When the status is OFF, the serial port is not available.	OFF
Baud Rate	Select from "300", "600", "1200", "2400", "4800", "9600", "19200", "38400", "57600" or "115200".	115200
Data Bits	Select from "7" or "8".	8
Stop Bits	Select from "1" or "2".	1
Parity	Select from "None", "Odd" or "Even".	None
Flow control	Select from "None", "Software" or "Hardware".	None
Data Packing		
Packing Timeout	Set the packing timeout. The serial port will queue the data in the buffer and send the data to the Cellular WAN/Ethernet WAN when it reaches the Interval Timeout in the field. The unit is milliseconds. Note: Data will also be sent as specified by the packet length even when data is not reaching the interval timeout in the field.	50
Packing Length	Set the packet length. The Packet length setting refers to the maximum amount of data that is allowed to accumulate in the serial port buffer before sending. When a packet length between 1 and 3000 bytes is specified, data in the buffer will be sent as soon it reaches the specified length.	1200

Server Settings

Item	Description	Default
Application Mode	Select from "Transparent", "Modbus RTU Router" or "Modbus ASCII Router". <ul style="list-style-type: none"> Transparent: Router will transmit the serial data transparently Modbus RTU Router: Router will translate the Modbus RTU data to Modbus TCP data and sent out, and vice versa Modbus ASCII Router: Router will translate the Modbus ASCII data to Modbus TCP data and sent out, and vice versa 	Transparent
Protocol	Select from "TCP Client", "TCP Server", or "UDP". <ul style="list-style-type: none"> TCP Client: Router works as TCP client, initiate TCP connection to TCP server. Server address supports both IP and domain name TCP Server: Router works as TCP server, listening for connection request from TCP client UDP: Router works as UDP client 	TCP Client
Server Address	Enter the address of server which will receive the data sent from router's serial port. IP address or domain name will be available.	Null
Server Port	Enter the specified port of server which is used for receiving the serial data.	Null
Local IP @ Transparent	Enter router's LAN IP which will forward to the internet port of router.	Null
Local Port @ Transparent	Enter the port of router's LAN IP.	Null
Local IP @ Modbus	Enter the local IP of under Modbus mode.	Null
Local Port @ Modbus	Enter the local port of under Modbus mode.	Null

Click the "Status" column to view the current serial port type.

Serial Port	Status															
Serial Port Status list <table border="1"> <thead> <tr> <th>Index</th> <th>Type</th> <th>TX</th> <th>RX</th> <th>Connection Status</th> </tr> </thead> <tbody> <tr> <td>1</td> <td>RS232</td> <td>0B</td> <td>0B</td> <td></td> </tr> <tr> <td>2</td> <td>RS485</td> <td>0B</td> <td>0B</td> <td></td> </tr> </tbody> </table>		Index	Type	TX	RX	Connection Status	1	RS232	0B	0B		2	RS485	0B	0B	
Index	Type	TX	RX	Connection Status												
1	RS232	0B	0B													
2	RS485	0B	0B													

4.3 Network

4.3.1 Route

This section allows you to set the static route. Static routes are routes based on destination addresses. Up to 20 static routes can be added to the router. Routing Information Protocol, or RIP (Route Information Protocol), is widely used in small networks with stable rate changes. The OSPF (Open Shortest Path First) protocol is used for decision routing within a single autonomous system and is suitable for large networks.

Click Network> Routing> Static Route to enter the static routing table, which allows users to manually add, delete, or modify static routing rules.

Static Route

Static Route		Status			
^ Static Route Table					
Index	Description	Destination	Netmask	Gateway	Interface

Click **+** to add static route. The maximum count is 20.

Static Route

^ Static Route

Index:

Description:

Destination:

Netmask:

Gateway:

Interface:

Static Route		
Item	Description	Default
Index	Indicate the ordinal of the list.	--
Description	Enter a description for this route.	Null
Destination	Enter the IP address of destination host or destination network.	Null
Netmask	Enter the Netmask of destination host or destination network.	Null
Router	Define the router of the destination.	Null
Interface	Choose the corresponding port of the link that you want to configure.	wwan

Status

This window allows you to view the status of route.

Static Route		Status			
^ Route Table					
Index	Destination	Netmask	Gateway	Interface	Metric
1	0.0.0.0	0.0.0.0	10.122.74.9	wwan	0
2	10.122.74.8	255.255.255.248	0.0.0.0	wwan	0
3	172.16.0.0	255.255.0.0	0.0.0.0	lan0	0

4.3.2 Firewall

This section allows you to set the firewall and its related parameters, including Filtering, Port Mapping, Custom Rules, DMZ and Status. Filtering rules allow users to custom accept or discard a specified access source, filtering its IP address or MAC address.

Click "> firewall > filter" to display as follows:

Filtering

The filtering rules can be used to either accept or block certain users or ports from accessing your router.

Filtering	Port Mapping	Custom Rules	DMZ	Status			
^ General Settings							
Enable Filtering		<input checked="" type="checkbox"/> ON <input type="checkbox"/> OFF					
Default Filtering Policy		Accept <input type="button" value="v"/> <input type="button" value="?"/>					
^ Access Control Settings							
Enable Remote SSH Access		<input type="checkbox"/> ON <input checked="" type="checkbox"/> OFF					
Enable Local SSH Access		<input checked="" type="checkbox"/> ON <input type="checkbox"/> OFF					
Enable Remote Telnet Access		<input type="checkbox"/> ON <input checked="" type="checkbox"/> OFF					
Enable Local Telnet Access		<input checked="" type="checkbox"/> ON <input type="checkbox"/> OFF					
Enable Remote HTTP Access		<input type="checkbox"/> ON <input checked="" type="checkbox"/> OFF					
Enable Local HTTP Access		<input checked="" type="checkbox"/> ON <input type="checkbox"/> OFF					
Enable Remote HTTPS Access		<input checked="" type="checkbox"/> ON <input type="checkbox"/> OFF					
Enable Remote Ping Respond		<input checked="" type="checkbox"/> ON <input type="checkbox"/> OFF <input type="button" value="?"/>					
Enable DOS Defending		<input checked="" type="checkbox"/> ON <input type="checkbox"/> OFF					
Enable Console		<input checked="" type="checkbox"/> ON <input type="checkbox"/> OFF <input type="button" value="?"/>					
Enable VPN NAT Traversal		<input type="checkbox"/> ON <input checked="" type="checkbox"/> OFF <input type="button" value="?"/>					
^ Whitelist Rules <input type="button" value="?"/>							
Index	Description	Source Address	<input type="button" value="+"/>				
^ Filtering Rules							
Index	Source Address	Source Port	Source MAC	Target Address	Target Port	Protocol	<input type="button" value="+"/>

Click to add whitelist rules. The maximum count is 50.

Filtering	
^ Whitelist Rules	
Index	<input type="text" value="1"/>
Description	<input type="text"/>
Source Address	<input type="text"/> <input type="button" value="?"/>

Click **+** to add filtering rules. The maximum count is 50. The window is displayed as below when defaulting “All” or choosing “ICMP” as the protocol. Here take “All” as an example.

Filtering

^ Filtering Rules

Index

Description

Source Address ?

Source MAC ?

Target Address ?

Protocol v

Action v

The window is displayed as below when choosing “TCP”, “UDP” or “TCP-UDP” as the protocol. Here take “TCP” as an example.

^ Filtering Rules

Index

Description

Source Address ?

Source Port ?

Source MAC ?

Target Address ?

Target Port ?

Protocol v

Action v

Filtering		
Item	Description	Default
General Settings		
Enable Filtering	Click the toggle button to enable/disable the filtering option.	ON
Default Filtering Policy	Select from “Accept” or “Drop”. Cannot be changed when filtering rules table is not empty. <ul style="list-style-type: none"> Accept: Router will accept all the connecting requests except the hosts which fit the drop filter list Drop: Router will drop all the connecting requests except the hosts which fit the accept filter list 	Accept
Access Control Settings		
Enable Remote SSH Access	Click the toggle button to enable/disable this option. When enabled, the Internet user can access the router remotely via SSH.	OFF
Enable Local SSH Access	Click the toggle button to enable/disable this option. When enabled, the LAN user can access the router locally via SSH.	ON

Filtering		
Item	Description	Default
Enable Remote Telnet Access	Click the toggle button to enable/disable this option. When enabled, the Internet user can access the router remotely via Telnet.	OFF
Enable Local Telnet Access	Click the toggle button to enable/disable this option. When enabled, the LAN user can access the router locally via Telnet.	ON
Enable Remote HTTP Access	Click the toggle button to enable/disable this option. When enabled, the Internet user can access the router remotely via HTTP.	OFF
Enable Local HTTP Access	Click the toggle button to enable/disable this option. When enabled, the LAN user can access the router locally via HTTP.	ON
Enable Remote HTTPS Access	Click the toggle button to enable/disable this option. When enabled, the Internet user can access the router remotely via HTTPS.	ON
Enable Remote Ping Respond	Click the toggle button to enable/disable this option. When enabled, the router will reply to the Ping requests from other hosts on the Internet.	ON
Enable DOS Defending	Click the toggle button to enable/disable this option. When enabled, the router will defend the DOS. Dos attack is an attempt to make a machine or network resource unavailable to its intended users.	ON
Enable Console	Click the toggle button to enable/disable this option. When enabled, the user can access the router via Console.	ON
Enable the vpn_nat traversal	Click the toggle button to enable/disable this option. When enabled, the router automatically modifies the IP address of the VPN header received by WAN/WWAN to the IP address of the device under LAN port and sends it out.	OFF
Whitelist Rules		
Item	Description	Default
Index	Indicate the ordinal of the list.	--
Description	Enter a description for this whitelist rule.	Null
Source Address	Defines if access is allowed from one or a range of IP addresses which are defined by Source IP Address, or every IP addresses.	Null
Filtering Rules		
Index	Indicate the ordinal of the list.	--
Description	Enter a description for this filtering rule.	Null
Source Address	Defines if access is allowed from one or a range of IP addresses which are defined by Source IP Address, or every IP addresses.	Null
Source Port	Specify an access originator and enter its source port.	Null
Source MAC	Enter the MAC address of the defined source IP address.	Null
Target Address	Defines if access is allowed to one or a range of IP addresses which are defined by Target IP Address, or every IP addresses.	Null
Target Port	Enter the target port which the access originator wants to access.	Null
Protocol	Select from "All", "TCP", "UDP", "ICMP" or "TCP-UDP". Note: It is recommended that you choose "All" if you don't know which protocol of your application to use.	All
Action	Select from "Accept" or "Drop". <ul style="list-style-type: none"> Accept: When Default Filtering Policy is drop, router will drop all 	Drop

Filtering		
Item	Description	Default
	the connecting requests except the hosts which fit this accept filtering list <ul style="list-style-type: none"> Drop: When Default Filtering Policy is accept, router will accept all the connecting requests except the hosts which fit this drop filtering list 	

Port Mapping

Port mapping is defined manually in the router, and the data received from some ports in the public network are all forwarded to a port of an IP in the internal network. Click "network > firewall > port mapping" to display as follows:

Filtering
Port Mapping
Custom Rules
DMZ
Status

^ Port Mapping Rules

Index	Description	Internet Port	Local IP	Local Port	Protocol	+
-------	-------------	---------------	----------	------------	----------	---

Click **+** to add port mapping rules. The maximum rule count is 50.

Port Mapping

^ Port Mapping Rules

Index

Description

Remote IP ?

Internet Port ?

Local IP

Local Port ?

Protocol TCP-UDP v

Port Mapping Rules		
Item	Description	Default
Index	Indicate the ordinal of the list.	--
Description	Enter a description for this port mapping.	Null
Remote IP	Specify the host or network which can access to the local IP address. Empty means unlimited. e.g. 10.10.10.10/255.255.255.255 or 192.168.1.0/24	Null
Internet Port	Set the internet port of router which can be accessed by other hosts from internet.	Null
Local IP	Enter router's LAN IP which will forward to the internet port of router.	Null
Local Port	Enter the port of router's LAN IP.	Null
Protocol	Select from "TCP", "UDP" or "TCP-UDP" as your application required.	TCP-UDP

Custom Rules

Custom rules, that is, rules that you define yourself. Click "Network> Firewall> Custom Rules" to display as follows:

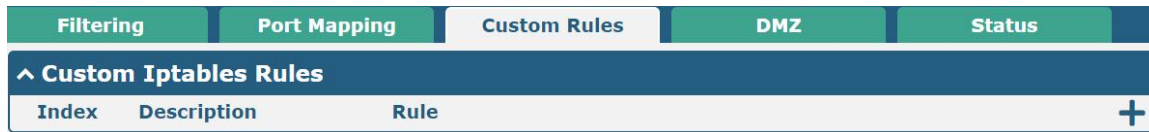

Click **+** to add custom rules. The maximum rule count is 50.

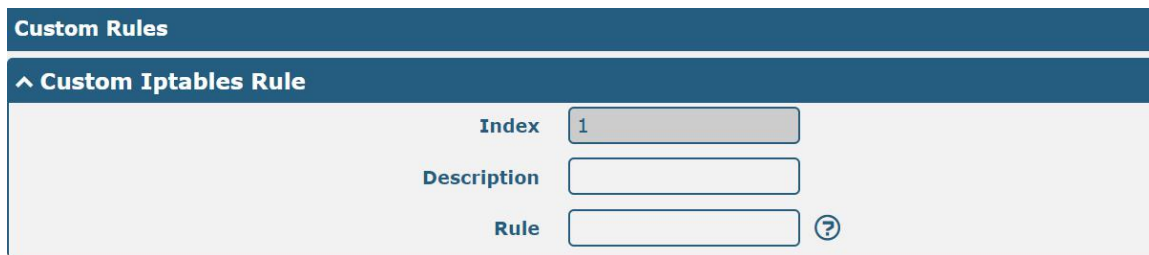

Custom firewall Rules		
Item	Description	Default
Index	Indicate the ordinal of the list.	--
Description	Enter a description for this custom rule.	Null
Rule	Specify one custom rule.	Null

DMZ

The DMZ, also known as the Demilitarized Zone, is being transformed into a large swath of land. It is to solve the problem that the access user of the external network cannot access the internal network server after installing the firewall, and set up a buffer between the non-secure system and the secure system. A DMZ host is an Intranet host that has open access to all ports except the occupied and forwarded ports to the specified address.

Click "> firewall > DMZ" to display the following:



DMZ Settings		
Item	Description	Default
Enable DMZ	Click the toggle button to enable/disable DMZ. DMZ host is a host on the internal network that has all ports exposed, except those ports otherwise forwarded.	OFF

Host IP Address	Enter the IP address of the DMZ host on your internal network.	Null
Source IP Address	Set the address which can talk to the DMZ host. 0.0.0.0 means for any addresses.	Null

Status

This window allows you to view the status of chain input, chain forward and chain output.

Filtering	Port Mapping	Custom Rules	DMZ	Status			
^ Chain Input							
Index	Packets	Target	Protocol	In	Out	Source	Destination
1	0	DROP	tcp	wwan	*	0.0.0.0/0	0.0.0.0/0
2	0	DROP	tcp	wwan	*	0.0.0.0/0	0.0.0.0/0
3	0	DROP	tcp	wwan	*	0.0.0.0/0	0.0.0.0/0
4	0	REJECT	tcp	*	*	0.0.0.0/0	0.0.0.0/0
5	52	ACCEPT	tcp	*	*	0.0.0.0/0	0.0.0.0/0
6	0	DROP	tcp	*	*	0.0.0.0/0	0.0.0.0/0
7	0	ACCEPT	tcp	*	*	0.0.0.0/0	0.0.0.0/0
8	0	DROP	tcp	*	*	0.0.0.0/0	0.0.0.0/0
9	0	ACCEPT	icmp	*	*	0.0.0.0/0	0.0.0.0/0
10	0	DROP	icmp	*	*	0.0.0.0/0	0.0.0.0/0
^ Chain Forward							
Index	Packets	Target	Protocol	In	Out	Source	Destination
1	0	TCPMSS	tcp	*	*	0.0.0.0/0	0.0.0.0/0
^ Chain Output							
Index	Packets	Target	Protocol	In	Out	Source	Destination

4.3.3 IP Passthrough

Click **Network > IP Passthrough > IP Passthrough** to enable or disable the IP Pass-through option.



If router enables the IP Pass-through, the terminal device (such as PC) will enable the DHCP Client mode and connect to LAN port of the router; and after the router dial up successfully, the PC will automatically obtain the IP address and DNS server address which assigned by ISP. To use this function, the main link needs to be set to WWAN, and the backup link needs to be set to None.

4.4 VPN

4.4.1 IPsec

This section allows you to set the IPsec and the related parameters. Internet Protocol Security (IPsec) is a protocol suite for secure Internet Protocol (IP) communications that works by authenticating and encrypting each IP packet of a communication session.

Click **VPN > IPsec > general** to set IPsec parameters.

General

General Settings @ General		
Item	Description	Default
Keepalive	Set the time to live in seconds. The router sends keep-alive packets to the NAT (Network Address Translation) server at regular intervals to prevent the records on the NAT table from disappearing.	20
Optimize DH Size	Click the toggle button to enable/disable this option. When enabled, when using dhgroup17 or dhgroup18, it helps to shorten the time to generate the dh key.	OFF
Debug Enable	Click the toggle button to enable/disable this option. Enable for IPsec VPN information output to the debug port.	OFF

Tunnel

Click **+** to add IPsec tunnel settings. The maximum count is 6.

Tunnel

^ **General Settings**

Index	<input style="width: 80%;" type="text" value="1"/>
Enable	<input checked="" type="checkbox"/> ON <input type="checkbox"/> OFF
Description	<input style="width: 80%;" type="text"/>
Gateway	<input style="width: 80%;" type="text"/> ?
Mode	<input style="width: 80%;" type="text" value="Tunnel"/> v
Protocol	<input style="width: 80%;" type="text" value="ESP"/> v
Local Subnet	<input style="width: 80%;" type="text"/> ?
Remote Subnet	<input style="width: 80%;" type="text"/> ?
Link Binding	<input style="width: 80%;" type="text" value="Unspecified"/> v ?

General Settings @ Tunnel		
Item	Description	Default
Index	Indicate the ordinal of the list.	--
Enable	Click the toggle button to enable/disable this IPsec tunnel.	ON
Description	Enter a description for this IPsec tunnel.	Null
Router	Enter the address of remote side IPsec VPN server. 0.0.0.0 represents for any address.	Null
Mode	Select from "Tunnel" and "Transport". <ul style="list-style-type: none"> Tunnel: Commonly used between routers, or at an end-station to a router, the router acting as a proxy for the hosts behind it Transport: Used between end-stations or between an end-station and a router, if the router is being treated as a host-for example, an encrypted Telnet session from a workstation to a router, in which the router is the actual destination 	Tunnel
Protocol	Select the security protocols from "ESP" and "AH". <ul style="list-style-type: none"> ESP: Use the ESP protocol AH: Use the AH protocol 	ESP
Local Subnet	Enter the local subnet's address with mask protected by IPsec, e.g. 192.168.1.0/24	Null
Remote Subnet	Enter the remote subnet's address with mask protected by IPsec, e.g. 10.8.0.0/24	Null
Link binding	Select the link to build Ipsec.	Unbound

The window is displayed as below when choosing "PSK" as the authentication type.

^ IKE Settings

IKE Type	IKEv1	v
Negotiation Mode	Main	v
Encryption Algorithm	3DES	v
Authentication Algorithm	SHA1	v
IKE DH Group	DHgroup2	v
Authentication Type	PSK	v
PSK Secret	<input type="text"/>	
Local ID Type	Default	v
Remote ID Type	Default	v
IKE Lifetime	86400	?

The window is displayed as below when choosing “CA” as the authentication type.

^ IKE Settings

IKE Type	IKEv1	v
Negotiation Mode	Main	v
Encryption Algorithm	3DES	v
Authentication Algorithm	SHA1	v
IKE DH Group	DHgroup2	v
Authentication Type	CA	v
Private Key Password	<input type="text"/>	
IKE Lifetime	86400	?

The window is displayed as below when choosing “PKCS#12” as the authentication type.

^ IKE Settings

IKE Type	IKEv1	v
Negotiation Mode	Main	v
Encryption Algorithm	3DES	v
Authentication Algorithm	SHA1	v
IKE DH Group	DHgroup2	v
Authentication Type	PKCS#12	v
Private Key Password	<input type="text"/>	
IKE Lifetime	86400	?

The window is displayed as below when choosing “xAuth PSK” as the authentication type.

^ IKE Settings

IKE Type	<input type="text" value="IKEv1"/>	v
Negotiation Mode	<input type="text" value="Main"/>	v
Encryption Algorithm	<input type="text" value="3DES"/>	v
Authentication Algorithm	<input type="text" value="SHA1"/>	v
IKE DH Group	<input type="text" value="DHgroup2"/>	v
Authentication Type	<input type="text" value="xAuth PSK"/>	v
PSK Secret	<input type="text"/>	
Local ID Type	<input type="text" value="Default"/>	v
Remote ID Type	<input type="text" value="Default"/>	v
Username	<input type="text"/>	?
Password	<input type="text"/>	?
IKE Lifetime	<input type="text" value="86400"/>	?

The window is displayed as below when choosing “xAuth CA” as the authentication type.

^ IKE Settings

IKE Type	<input type="text" value="IKEv1"/>	v
Negotiation Mode	<input type="text" value="Main"/>	v
Encryption Algorithm	<input type="text" value="3DES"/>	v
Authentication Algorithm	<input type="text" value="SHA1"/>	v
IKE DH Group	<input type="text" value="DHgroup2"/>	v
Authentication Type	<input type="text" value="xAuth CA"/>	v
Private Key Password	<input type="text"/>	
Username	<input type="text"/>	?
Password	<input type="text"/>	?
IKE Lifetime	<input type="text" value="86400"/>	?

IKE Settings		
Item	Description	Default
IKE Type	Select from “IKEv1” and “IKEv2”.	IKEv1
Negotiation Mode	Select from “Main” and “Aggressive” for the IKE negotiation mode in phase 1. If the IP address of one end of an IPsec tunnel is obtained dynamically, the IKE negotiation mode must be aggressive. In this case, SAs can be established as long as the username and password are correct.	Main
Authentication Algorithm	Select from “MD5”, “SHA1”, “SHA2 256” or “SHA2 512” to be used in IKE negotiation.	MD5
Encrypt Algorithm	Select from “3DES”, “AES128”, “AES192” and “AES256” to be used in IKE negotiation.	3DES

IKE Settings		
Item	Description	Default
	<ul style="list-style-type: none"> 3DES: Use 168-bit 3DES encryption algorithm in CBC mode AES128: Use 128-bit AES encryption algorithm in CBC mode AES128: Use 192-bit AES encryption algorithm in CBC mode AES256: Use 256-bit AES encryption algorithm in CBC mode 	
IKE DH Group	Select from "DHgroup1", "DHgroup2", "DHgroup5", "DHgroup14", "DHgroup15", "DHgroup16", "DHgroup17" or "DHgroup18" to be used in key negotiation phase 1.	DHgroup2
Authentication Type	Select from "PSK", "CA", "xAuth PSK", "PKCS#12" and "xAuth CA" to be used in IKE negotiation. <ul style="list-style-type: none"> PSK: Pre-shared Key CA: Certification Authority xAuth: Extended Authentication to AAA server PKCS#12: Exchange digital certificate authentication 	PSK
PSK Secret	Enter the pre-shared key.	Null
Local ID Type	Select from "Default", "FQDN" and "User FQDN" for IKE negotiation. <ul style="list-style-type: none"> Default: Uses an IP address as the ID in IKE negotiation FQDN: Uses an FQDN type as the ID in IKE negotiation. If this option is selected, type a name without any at sign (@) for the local security router, e.g., test.robustel.com User FQDN: Uses a user FQDN type as the ID in IKE negotiation. If this option is selected, type a name string with a sign "@" for the local security router, e.g., test@robustel.com 	Default
Remote ID Type	Select from "Default", "FQDN" and "User FQDN" for IKE negotiation. <ul style="list-style-type: none"> Default: Uses an IP address as the ID in IKE negotiation FQDN: Uses an FQDN type as the ID in IKE negotiation. If this option is selected, type a name without any at sign (@) for the local security router, e.g., test.robustel.com User FQDN: Uses a user FQDN type as the ID in IKE negotiation. If this option is selected, type a name string with a sign "@" for the local security router, e.g., test@robustel.com 	Default
IKE Lifetime	Set the lifetime in IKE negotiation. Before an SA expires, IKE negotiates a new SA. As soon as the new SA is set up, it takes effect immediately and the old one will be cleared automatically when it expires.	86400
Private Key Password	Enter the private key under the "CA" and "xAuth CA" authentication types.	Null
Username	Enter the username used for the "xAuth PSK" and "xAuth CA" authentication types.	Null
Password	Enter the password used for the "xAuth PSK" and "xAuth CA" authentication types.	Null

If click **VPN > IPsec > Tunnel > General Settings**, and choose **ESP** as protocol. The specific parameter configuration is shown as below.

Tunnel

^ General Settings

Index	<input type="text" value="1"/>
Enable	<input checked="" type="checkbox"/> ON <input type="checkbox"/> OFF
Description	<input type="text"/>
Gateway	<input type="text"/> ?
Mode	<input type="text" value="Tunnel"/> v
Protocol	<input type="text" value="ESP"/> v
Local Subnet	<input type="text"/> ?
Remote Subnet	<input type="text"/> ?
Link Binding	<input type="text" value="Unspecified"/> v ?

^ IKE Settings

^ SA Settings

Encryption Algorithm	<input type="text" value="3DES"/> v
Authentication Algorithm	<input type="text" value="SHA1"/> v
PFS Group	<input type="text" value="DHgroup2"/> v
SA Lifetime	<input type="text" value="28800"/> ?
DPD Interval	<input type="text" value="30"/> ?
DPD Failures	<input type="text" value="150"/> ?

When the protocol in "Virtual Private Network> IPsec> Tunnel> General Settings" selects "AH", the SA settings are displayed as follows:

Tunnel

^ General Settings

Index	<input type="text" value="1"/>
Enable	<input checked="" type="checkbox"/> ON <input type="checkbox"/> OFF
Description	<input type="text"/>
Gateway	<input type="text"/> ?
Mode	<input type="text" value="Tunnel"/> v
Protocol	<input type="text" value="AH"/> v
Local Subnet	<input type="text"/> ?
Remote Subnet	<input type="text"/> ?
Link Binding	<input type="text" value="Unspecified"/> v ?

▼ IKE Settings

▲ SA Settings

Authentication Algorithm ▼

PFS Group ▼

SA Lifetime ?

DPD Interval ?

DPD Failures ?

▲ Advanced Settings

Enable Compression OFF

Enable Forceencaps OFF ?

Expert Options ?

SA Settings		
Item	Description	Default
Encrypt Algorithm	Select from “3DES”, “AES128”, “AES192” or “AES256” when you select “ESP” in “Protocol”. Higher security means more complex implementation and lower speed. DES is enough to meet general requirements. Use 3DES when high confidentiality and security are required.	3DES
Authentication Algorithm	Select from “MD5”, “SHA1”, “SHA2 256” or “SHA2 512” to be used in SA negotiation.	MD5
PFS Group	Select from “PFS(N/A)”, “DHgroup1”, “DHgroup2”, “DHgroup5”, “DHgroup14”, “DHgroup15”, “DHgroup16”, “DHgroup17” or “DHgroup18” to be used in SA negotiation.	DHgroup2
SA Lifetime	Set the IPsec SA lifetime. When negotiating to set up IPsec SAs, IKE uses the smaller one between the lifetime set locally and the lifetime proposed by the peer.	28800
DPD Interval	Set the interval after which DPD is triggered if no IPsec protected packets is received from the peer. DPD is a Dead peer detection. DPD irregularly detects dead IKE peers. When the local end sends an IPsec packet, DPD checks the time the last IPsec packet was received from the peer. If the time exceeds the DPD interval, it sends a DPD hello to the peer. If the local end receives no DPD acknowledgment within the DPD packet retransmission interval, it retransmits the DPD hello. If the local end still receives no DPD acknowledgment after having made the maximum number of retransmission attempts, it considers the peer already dead, and clears the IKE SA and the IPsec SAs based on the IKE SA.	30
DPD Failures	Set the timeout of DPD (Dead Peer Detection) packets.	150
Advanced Settings		
Enable Compression	Click the toggle button to enable/disable this option. Enable to compress the inner headers of IP packets.	OFF
Enable Forceencaps		OFF

SA Settings		
Item	Description	Default
Expert Options	Add more PPP configuration options here, format: config-desc;config-desc, e.g. protostack=netkey;plutodebug=none	Null

Status

This section allows you to view the status of the IPsec tunnel.

General Tunnel Status x509

^ IPsec Tunnel Status

Index	Description	Status	Uptime
-------	-------------	--------	--------

x509

User can upload the CA certificates for the IPsec tunnel in this section.

General Tunnel Status x509

^ X509 Settings

Tunnel Name: Tunnel 1

Local Certificate: Choose File No file chosen

Remote Certificate: Choose File No file chosen

Private Key: Choose File No file chosen

CA Certificate: Choose File No file chosen

PKCS#12 Certificate: Choose File No file chosen

^ Certificate Files

Index	File Name	File Size	Modification Time
-------	-----------	-----------	-------------------

x509		
Item	Description	Default
X509 Settings		
Tunnel Name	Choose a valid tunnel. Select from "Tunnel 1", "Tunnel 2", "Tunnel 3", "Tunnel 4", "Tunnel 5", or "Tunnel 6".	Tunnel 1
Local Certificate	Click on "Choose File" to locate the certificate file from local computer, and then import this file into your router.	--
Remote Certificate	Click on "Choose File" to locate the certificate file from remote computer, and then import this file into your router.	--
Private Key	Click on "Choose File" to locate the private key file.	--
CA Certificate	Click on "Choose File" to locate the correct CA certificate file.	--
PKCS#12 Certificate	Click on "Choose File" to locate the PKCS # 12 certificate file.	--

x509		
Item	Description	Default
X509 Settings		
Certificate Files		
Index	Indicate the ordinal of the list.	--
Filename	Show the imported certificate's name.	Null
File Size	Show the size of the certificate file.	Null
Last Modification	Show the timestamp of that the last time to modify the certificate file.	Null

4.4.2 OpenVPN

This section allows you to set the OpenVPN and the related parameters. OpenVPN is an open-source software application that implements virtual private network (VPN) techniques for creating secure point-to-point or site-to-site connections in routed or bridged configurations and remote access facilities. Router supports point-to-point and point-to-points connections.

Click "**VPN > OpenVPN > OpenVPN**" to display as follows:

OpenVPN

OpenVPN	Status	x509
^ Tunnel Settings Index Enable Description Mode +		
^ Password Manage Index Username +		
^ Client Manage Index Enable Common Name Client IP Address +		

Click **+** to add OpenVPN tunnel settings. The maximum count is 5. By default, the mode is "P2P". The window is displayed as below when choosing "P2P" as the mode.

^ General Settings

Index

Enable ON OFF

Description

Mode Mode

TLS Mode TLS Mode

Protocol

Peer Address

Peer Port

Listen IP Address

Listen Port

Interface Type

Authentication Type Authentication Type

Local IP

Remote IP

Encrypt Algorithm

Authentication Algorithm

Keepalive Interval Keepalive Interval

Keepalive Timeout Keepalive Timeout

TUN MTU

Max Frame Size

Enable Compression ON OFF

Enable NAT ON OFF

Verbose Level Verbose Level

The window is displayed as below when choosing “Auto” as the mode.



^ General Settings

Index

Enable ON OFF

Description

Mode v ⓘ

Private Key Password

Enable Client Status ON OFF ⓘ

Enable NAT ON OFF

The window is displayed as below when choosing “Client” as the mode.

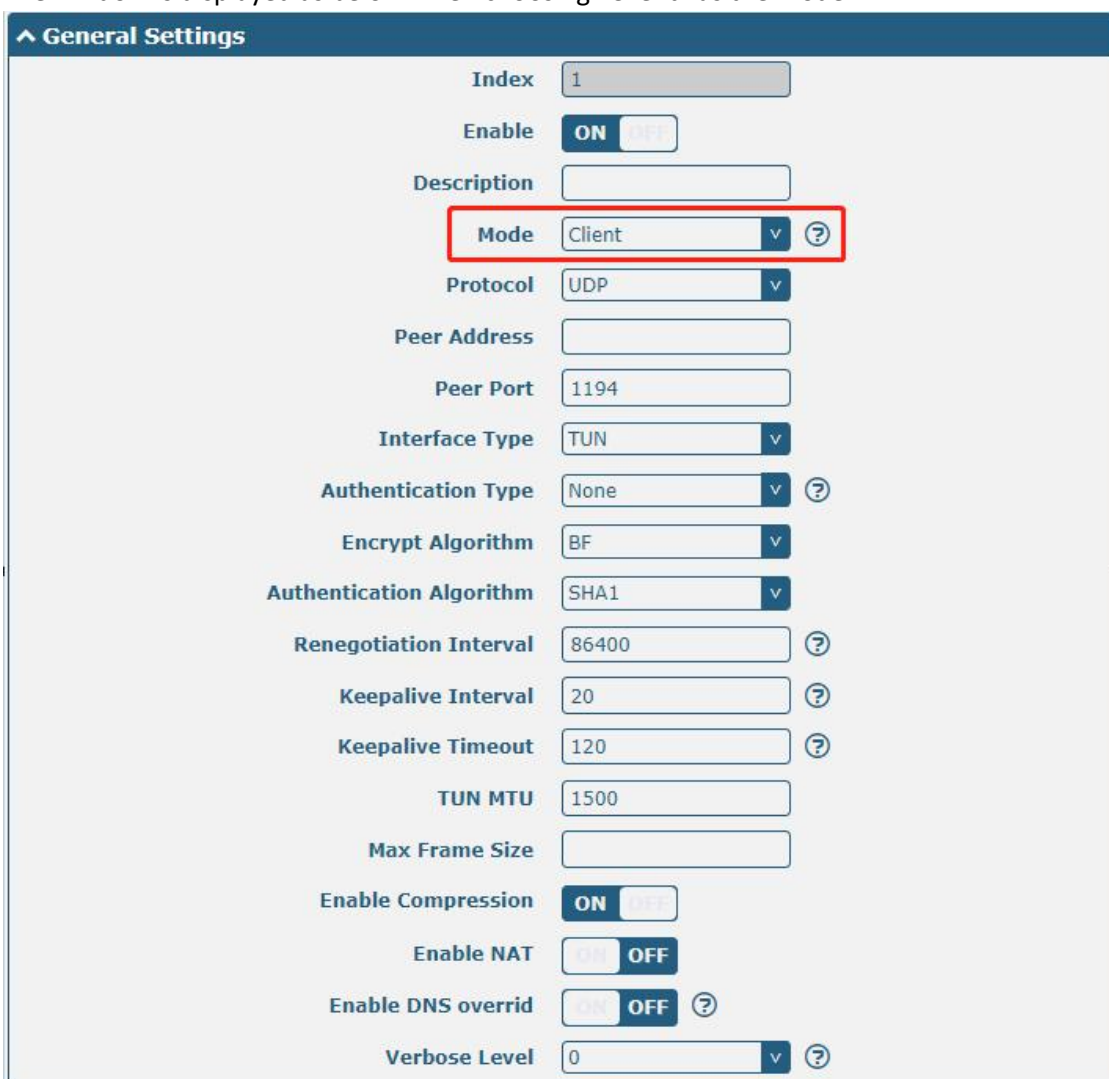

^ General Settings

Index

Enable ON OFF

Description

Mode v ⓘ

Protocol v

Peer Address

Peer Port

Interface Type v

Authentication Type v ⓘ

Encrypt Algorithm v

Authentication Algorithm v

Renegotiation Interval ⓘ

Keepalive Interval ⓘ

Keepalive Timeout ⓘ

TUN MTU

Max Frame Size

Enable Compression ON OFF

Enable NAT ON OFF

Enable DNS overrid ON OFF ⓘ

Verbose Level v ⓘ

The window is displayed as below when choosing “Server” as the mode.

^ General Settings

Index	<input type="text" value="1"/>
Enable	<input checked="" type="checkbox"/> ON <input type="checkbox"/> OFF
Description	<input type="text"/>
Mode	<input type="text" value="Server"/> v ⓘ
Protocol	<input type="text" value="UDP"/> v
Listen IP Address	<input type="text"/>
Listen Port	<input type="text" value="1194"/>
Interface Type	<input type="text" value="TUN"/> v
Authentication Type	<input type="text" value="None"/> v ⓘ
Enable IP Pool	<input type="checkbox"/> ON <input checked="" type="checkbox"/> OFF
Client Subnet	<input type="text" value="10.8.0.0"/>
Client Subnet Netmask	<input type="text" value="255.255.255.0"/>
Encrypt Algorithm	<input type="text" value="BF"/> v
Authentication Algorithm	<input type="text" value="SHA1"/> v
Renegotiation Interval	<input type="text" value="86400"/> ⓘ
Max Clients	<input type="text" value="10"/>
Keepalive Interval	<input type="text" value="20"/> ⓘ
Keepalive Timeout	<input type="text" value="120"/> ⓘ
TUN MTU	<input type="text" value="1500"/>
Max Frame Size	<input type="text"/>
Enable Compression	<input checked="" type="checkbox"/> ON <input type="checkbox"/> OFF
Enable Default Gateway	<input type="checkbox"/> ON <input checked="" type="checkbox"/> OFF
Enable NAT	<input type="checkbox"/> ON <input checked="" type="checkbox"/> OFF
Verbose Level	<input type="text" value="0"/> v ⓘ

The window is displayed as below when choosing “None” as the authentication type.

^ General Settings

Index	<input type="text" value="1"/>
Enable	<input checked="" type="checkbox"/> ON <input type="checkbox"/> OFF
Description	<input type="text"/>
Mode	<input type="text" value="Client"/> v ⓘ
Protocol	<input type="text" value="UDP"/> v
Peer Address	<input type="text"/>
Peer Port	<input type="text" value="1194"/>
Interface Type	<input type="text" value="TUN"/> v
Authentication Type	<input type="text" value="None"/> v ⓘ
Encrypt Algorithm	<input type="text" value="BF"/> v
Authentication Algorithm	<input type="text" value="SHA1"/> v
Renegotiation Interval	<input type="text" value="86400"/> ⓘ
Keepalive Interval	<input type="text" value="20"/> ⓘ
Keepalive Timeout	<input type="text" value="120"/> ⓘ
TUN MTU	<input type="text" value="1500"/>
Max Frame Size	<input type="text"/>
Enable Compression	<input checked="" type="checkbox"/> ON <input type="checkbox"/> OFF
Enable NAT	<input type="checkbox"/> ON <input checked="" type="checkbox"/> OFF
Enable DNS overrid	<input type="checkbox"/> ON <input checked="" type="checkbox"/> OFF ⓘ
Verbose Level	<input type="text" value="0"/> v ⓘ

The window is displayed as below when choosing “Preshared” as the authentication type.

^ General Settings

Index	<input type="text" value="1"/>
Enable	<input checked="" type="checkbox"/> ON <input type="checkbox"/> OFF
Description	<input type="text"/>
Mode	<input type="text" value="Client"/> v ?
Protocol	<input type="text" value="UDP"/> v
Peer Address	<input type="text"/>
Peer Port	<input type="text" value="1194"/>
Interface Type	<input type="text" value="TUN"/> v
Authentication Type	<input type="text" value="Preshared"/> v ?
Encrypt Algorithm	<input type="text" value="BF"/> v
Authentication Algorithm	<input type="text" value="SHA1"/> v
Renegotiation Interval	<input type="text" value="86400"/> ?
Keepalive Interval	<input type="text" value="20"/> ?
Keepalive Timeout	<input type="text" value="120"/> ?
TUN MTU	<input type="text" value="1500"/>
Max Frame Size	<input type="text"/>
Enable Compression	<input checked="" type="checkbox"/> ON <input type="checkbox"/> OFF
Enable NAT	<input type="checkbox"/> ON <input checked="" type="checkbox"/> OFF
Enable DNS overrid	<input type="checkbox"/> ON <input checked="" type="checkbox"/> OFF ?
Verbose Level	<input type="text" value="0"/> v ?

The window is displayed as below when choosing “Password” as the authentication type.

General Settings

Index	<input type="text" value="1"/>
Enable	<input checked="" type="checkbox"/> ON <input type="checkbox"/> OFF
Description	<input type="text"/>
Mode	<input type="text" value="Client"/> <input type="button" value="v"/> <input type="button" value="?"/>
Protocol	<input type="text" value="UDP"/> <input type="button" value="v"/>
Peer Address	<input type="text"/>
Peer Port	<input type="text" value="1194"/>
Interface Type	<input type="text" value="TUN"/> <input type="button" value="v"/>
Authentication Type	<input type="text" value="Password"/> <input type="button" value="v"/> <input type="button" value="?"/>
Username	<input type="text"/>
Password	<input type="text"/>
Encrypt Algorithm	<input type="text" value="BF"/> <input type="button" value="v"/>
Authentication Algorithm	<input type="text" value="SHA1"/> <input type="button" value="v"/>
Renegotiation Interval	<input type="text" value="86400"/> <input type="button" value="?"/>
Keepalive Interval	<input type="text" value="20"/> <input type="button" value="?"/>
Keepalive Timeout	<input type="text" value="120"/> <input type="button" value="?"/>
TUN MTU	<input type="text" value="1500"/>
Max Frame Size	<input type="text"/>
Enable Compression	<input checked="" type="checkbox"/> ON <input type="checkbox"/> OFF
Enable NAT	<input type="checkbox"/> ON <input checked="" type="checkbox"/> OFF
Enable DNS overrid	<input type="checkbox"/> ON <input checked="" type="checkbox"/> OFF <input type="button" value="?"/>
Verbose Level	<input type="text" value="0"/> <input type="button" value="v"/> <input type="button" value="?"/>

The window is displayed as below when choosing “X509CA” as the authentication type.

^ General Settings

Index	<input type="text" value="1"/>
Enable	<input checked="" type="checkbox"/> ON <input type="checkbox"/> OFF
Description	<input type="text"/>
Mode	<input type="text" value="Client"/> v ?
Protocol	<input type="text" value="UDP"/> v
Peer Address	<input type="text"/>
Peer Port	<input type="text" value="1194"/>
Interface Type	<input type="text" value="TUN"/> v
Authentication Type	<input type="text" value="X509CA"/> v ?
Encrypt Algorithm	<input type="text" value="BF"/> v
Authentication Algorithm	<input type="text" value="SHA1"/> v
Renegotiation Interval	<input type="text" value="86400"/> ?
Keepalive Interval	<input type="text" value="20"/> ?
Keepalive Timeout	<input type="text" value="120"/> ?
TUN MTU	<input type="text" value="1500"/>
Max Frame Size	<input type="text"/>
Private Key Password	<input type="text"/>
Enable Compression	<input checked="" type="checkbox"/> ON <input type="checkbox"/> OFF
Enable NAT	<input type="checkbox"/> ON <input checked="" type="checkbox"/> OFF
Enable DNS overrid	<input type="checkbox"/> ON <input checked="" type="checkbox"/> OFF ?
Verbose Level	<input type="text" value="0"/> v ?

The window is displayed as below when choosing “X509CA Password” as the authentication type.

^ General Settings

Index

Enable ON OFF

Description

Mode ?

Protocol

Peer Address

Peer Port

Interface Type

Authentication Type ?

Username

Password

Encrypt Algorithm

Authentication Algorithm

Renegotiation Interval ?

Keepalive Interval ?

Keepalive Timeout ?

TUN MTU

Max Frame Size

Private Key Password

Enable Compression ON OFF

Enable NAT ON OFF

Enable DNS overrid ON OFF ?

Verbose Level ?

^ Advanced Settings

Enable HMAC Firewall ON OFF

Enable PKCS#12 ON OFF

Enable nsCertType ON OFF

Expert Options ?

General Settings @ OpenVPN		
Item	Description	Default
Index	Indicate the ordinal of the list.	--
Enable	Click the toggle button to enable/disable this OpenVPN tunnel.	ON

General Settings @ OpenVPN		
Item	Description	Default
Description	Enter a description for this OpenVPN tunnel.	Null
Mode	Select from "Auto", "P2P", "Client" or "Server".	Client
Protocol	Select from "UDP", "TCP-Client" or "TCP-Server".	UDP
Server Address	Enter the end-to-end IP address or the domain of the remote OpenVPN server.	Null
Server Port	Enter the end-to-end listener port or the listener port of the OpenVPN server.	1194
Listen IP Address	Enter the IP address or domain name.	Null
Listen Port	Enter the listener port at this end.	1194
Interface Type	Select from "TUN", "TAP" which are two different kinds of device interface for OpenVPN. The difference between TUN and TAP device is that a TUN device is a point-to-point virtual device on network while a TAP device is a virtual device on Ethernet.	TUN
Username	Enter the username used for "Password" or "X509CA Password" authentication type.	Null
Password	Enter the password used for "Password" or "X509CA Password" authentication type.	Null
Authentication Type	Select from "None", "Preshared", "Password", "X509CA" and "X509CA Password". Note: "None" and "Preshared" authentication type are only working with P2P mode.	None
Enable IP Pool	Click the toggle button to enable / disable this option. When enabled, the client will obtain a virtual IP from the address pool.	OFF
Local IP	Enter the local virtual IP.	10.8.0.1
Remote IP	Enter the remote virtual IP.	10.8.0.2
Client Subnet	Client virtual IP network address.	10.8.0.0
Client Subnet Netmask	Client virtual IP network address mask.	255.255.255.0
Encrypt Algorithm	Select from "BF", "DES", "DES-EDE3", "AES-128", "AES-192" and "AES-256". <ul style="list-style-type: none"> BF: Use 128-bit BF encryption algorithm in CBC mode DES: Use 64-bit DES encryption algorithm in CBC mode DES-EDE3: Use 192-bit 3DES encryption algorithm in CBC mode AES128: Use 128-bit AES encryption algorithm in CBC mode AES192: Use 192-bit AES encryption algorithm in CBC mode AES256: Use 256-bit AES encryption algorithm in CBC mode 	BF
Authentication Algorithm	Select from "MD5", "SHA1", "SHA256" or "SHA512".	SHA1
Max Clients	Set the retention timeout. If the connection continues to timeout during this time, the OpenVPN tunnel will be re-established.	10
Renegotiation Interval	Set the renegotiation interval. If connection failed, OpenVPN will renegotiate when the renegotiation interval reached.	86400

General Settings @ OpenVPN		
Item	Description	Default
Keepalive Interval	Set keepalive (ping) interval to check if the tunnel is active.	20
Keepalive Timeout	Set the keepalive timeout. Trigger OpenVPN restart after n seconds pass without reception of a ping or other packet from remote.	120
TUN MTU	Set the MTU for the tunnel.	1500
Max Frame Size	Sets the shard size of the data to be transmitted through the tunnel.	Null
Private Key Password	Enter the private key password under "X509CA" and "X509CA password" authentication.	Null
Enable Compression	Click the switch button to enable/disable this option. When enabled, this feature compresses the header of the IP packet.	ON
Enable DNS overrid	Click the switch button to enable/disable this option. When enabled, DNS pushed by the server is received as the local DNS server.	OFF
Enable Bridge With LAN0	Click the toggle button to enable / disable this option. When enabled, the virtual interface can be bridged with Lan0.	ON
Enable Default Gateway	Click the toggle button to enable / disable this option. When enabled, it will receive the gateway pushed by the server as the local gateway.	OFF
Enable Client Status	Click the toggle button to enable / disable this option. After the server is enabled, it can display the connected client status information.	OFF
Enable NAT	Click the toggle button to enable/disable the NAT option. When enabled, the source IP address of host behind router will be disguised before accessing the remote OpenVPN client.	OFF
Verbose Level	Select the level of the output log and values from 0 to 11. <ul style="list-style-type: none"> 0: No output except fatal errors 1~4: Normal usage range 5: Output R and W characters to the console for each packet read and write 6~11: Debug info range 	0
Advanced Settings @ OpenVPN		
Item	Description	Default
Enable HMAC Firewall	Click the toggle button to enable/disable this option. Add an additional layer of HMAC authentication on top of the TLS control channel to protect against DoS attacks.	OFF
Enable PKCS#12	Click the toggle button to enable/disable the PKCS#12 certificate. It is an exchange of digital certificate encryption standard, used to describe personal identity information.	OFF
Enable nsCertType	Click the toggle button to enable/disable nsCertType. Require that peer certificate was signed with an explicit nsCertType designation of "server".	OFF
Expert Options	Enter some other options of OpenVPN in this field. Each expression can be separated by a ','.	Null

Click user password management **+** to add a user name and password. The maximum count is 20 as shown below.

OpenVPN

^ **General Settings**

Index

Username

Password

General Settings @ Password Manage		
Item	Description	Default
Index	Indicate the ordinal of the list.	--
Username	In server mode, configure the client's user name.	Null
Password	In server mode, configure the password for the client's username.	Null

Click client administration **+** to add client information, The maximum count is 20 as shown below.

OpenVPN

^ **General Settings**

Index

Enable ON OFF

Common Name ?

Client IP Address

General Settings @ Client Manage		
Item	Description	Default
Index	Indicate the ordinal of the list.	--
Enable	Click the switch button to enable/disable this option.	ON
Common Name	Specify a common name for the client.	Null
Client IP Address	Specify the client's virtual IP address.	Null

Status

This section allows you to view the status of the OpenVPN tunnel.

OpenVPN
Status
x509

^ **OpenVPN Tunnel Status**

Index	Description	Status	Mode	Uptime	Local IP
-------	-------------	--------	------	--------	----------

^ **OpenVPN Client List**

Index	Common Name	Virtual IP	Real IP	Port
-------	-------------	------------	---------	------

This section is used to locate the certificates such as CA.

OpenVPN
Status
x509

^ X509 Settings
?

Tunnel Name

Mode

Root CA No file chosen

Certificate File No file chosen

Private Key No file chosen

TLS-Auth Key No file chosen

PKCS#12 Certificate No file chosen

^ Certificate Files

Index	File Name	File Size	Modification Time
-------	-----------	-----------	-------------------

x509		
Item	Description	Default
X509 Settings		
Tunnel Name	Choose a valid tunnel. Select from "Tunnel 1", "Tunnel 2", "Tunnel 3", "Tunnel 4", "Tunnel 5" or "Tunnel 6".	Tunnel 1
Mode	The tunnel mode set by the selected tunnel.	Client
Root CA	Click on "Choose File" to locate the root ca file ,and then import this file into your router.	--
Certificate File	Click on "Choose File" to locate the certificate file, and then import this file into your router.	--
Private Key	Click on "Choose File" to locate the private key file, and then import this file into your router.	--
TLS-Auth Key	Click on "Choose File" to locate the TLS-Auth key file, and then import this file into your router.	--
PKCS#12 Certificate	Click on "Choose File" to locate the PCKS#12 certificate file ,and then import this file into your router.	--
Certificate Files		
Index	Indicate the ordinal of the list.	--
Filename	Show the imported certificate's name.	Null
File Size	Show the size of the certificate file.	Null
Last Modification	Show the timestamp of that the last time to modify the certificate file.	Null

4.4.3 GRE

This section allows you to set the GRE and the related parameters. Generic Routing Encapsulation (GRE) is a tunneling protocol that can encapsulate a wide variety of network layer protocols inside virtual point-to-point links over an Internet Protocol network. There are two main uses of GRE protocol: internal protocol encapsulation and private address encapsulation.

GRE



Click **+** to add tunnel settings. The maximum count is 5.

Tunnel Settings @ GRE		
Item	Description	Default
Index	Indicate the ordinal of the list.	--
Enable	Click the toggle button to enable/disable this GRE tunnel. GRE (Generic Routing Encapsulation) is a protocol that encapsulates data packets so that it can route packets of other protocols in an IP network.	ON
Description	Enter a description for this GRE tunnel.	Null
Remote IP Address	Set the remote real IP address of the GRE tunnel.	Null
Local Virtual IP Address	Set the local virtual IP address of the GRE tunnel.	Null
Local Virtual Netmask	Set the local virtual Netmask of the GRE tunnel.	Null
Remote Virtual IP Address	Set the remote virtual IP Address of the GRE tunnel.	Null
Enable Default Route	Click the toggle button to enable/disable this option. When enabled, all	OFF

	the traffics of the router will go through the GRE VPN.	
Enable NAT	Click the toggle button to enable/disable this option. This option must be enabled when router under NAT environment.	OFF
Secrets	Set the key of the GRE tunnel.	Null

Status

This section allows you to view the GRE tunnel status.

GRE		Status			
^ GRE tunnel status					
Index	Description	Status	Local IP Address	Remote IP Address	Uptime

4.5 Services

4.5.1 Syslog

This section allows you to set the syslog parameters. The system log of the router can be saved in the local, also supports to be sent to remote log server and specified application debugging. By default, the “Log to Remote” option is disabled.

Syslog	
^ Syslog Settings	
Enable	<input checked="" type="checkbox"/> ON <input type="checkbox"/> OFF
Syslog Level	Debug <input type="button" value="v"/>
Save Position	RAM <input type="button" value="v"/> <input type="button" value="?"/>
Log to Remote	<input type="checkbox"/> ON <input checked="" type="checkbox"/> OFF <input type="button" value="?"/>

The window is displayed as below when enabling the “Log to Remote” option.

Syslog	
^ Syslog Settings	
Enable	<input checked="" type="checkbox"/> ON <input type="checkbox"/> OFF
Syslog Level	Debug <input type="button" value="v"/>
Save Position	RAM <input type="button" value="v"/> <input type="button" value="?"/>
Log to Remote	<input checked="" type="checkbox"/> ON <input type="checkbox"/> OFF <input type="button" value="?"/>
Add Identifier	<input type="checkbox"/> ON <input checked="" type="checkbox"/> OFF <input type="button" value="?"/>
Remote IP Address	<input type="text"/>
Remote Port	514 <input type="text"/>

Syslog Settings		
Item	Description	Default
Enable	Click the toggle button to enable/disable the Syslog settings option.	OFF
Syslog Level	Select from “Debug”, “Info”, “Notice”, “Warning” or “Error”, which from low to high. The lower level will output more syslog in detail.	Debug
Save Position	Select the save position from “RAM”, “NVM” or “Console”. Choose “RAM”, the data will be cleared after reboot. Note: It's not recommended that saving syslog to NVM (Non-Volatile Memory) for a long time.	RAM
Log to Remote	Click the toggle button to enable/disable this option. Enable to allow router sending syslog to the remote syslog server. You need to enter the IP and Port of the syslog server.	OFF
Add Identifier	Click the toggle button to enable/disable this option. When enabled, you can add serial number to syslog message which used for loading Syslog to RobustLink.	OFF
Remote IP Address	Enter the IP address of syslog server when enabling the “Log to Remote” option.	Null
Remote Port	Enter the port of syslog server when enabling the “Log to Remote” option.	514

4.5.2 Event

This section allows you to set the event parameters. Event feature provides an ability to send alerts by SNMP and RCMS when certain system events occur.

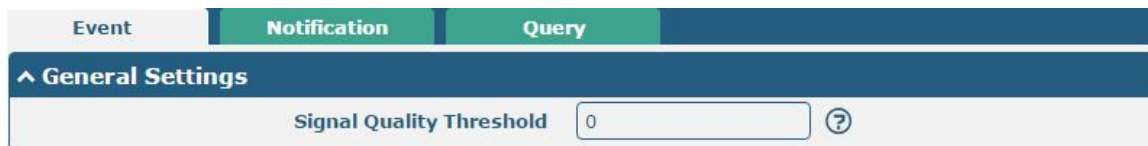

General Settings @ Event		
Item	Description	Default
Signal Quality Threshold	Set the threshold for signal quality. Router will generate a log event when the actual threshold is less than the specified threshold. 0 means disable this option.	0

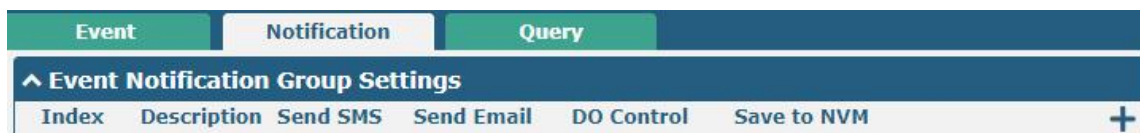

Click  button to add an Event parameters.

Notification

^ **General Settings**

Index	<input type="text" value="1"/>
Description	<input type="text"/>
Send SMS	<input type="checkbox"/> ON <input checked="" type="checkbox"/> OFF
Send Email	<input type="checkbox"/> ON <input checked="" type="checkbox"/> OFF
DO Control	<input type="checkbox"/> ON <input checked="" type="checkbox"/> OFF
Save to NVM	<input type="checkbox"/> ON <input checked="" type="checkbox"/> OFF 

^ Event Selection
?

System Startup	<input type="checkbox"/> OFF
System Reboot	<input type="checkbox"/> OFF
System Time Update	<input type="checkbox"/> OFF
Configuration Change	<input type="checkbox"/> OFF
Cellular Network Type Change	<input type="checkbox"/> OFF
Cellular Data Stats Clear	<input type="checkbox"/> OFF
Cellular Data Traffic Overflow	<input type="checkbox"/> OFF
Poor Signal Quality	<input type="checkbox"/> OFF
Wan data traffic stats clear	<input type="checkbox"/> OFF
Wan data traffic overflow	<input type="checkbox"/> OFF
Link Switching	<input type="checkbox"/> OFF
WAN Up	<input type="checkbox"/> OFF
WAN Down	<input type="checkbox"/> OFF
WLAN Up	<input type="checkbox"/> OFF
WLAN Down	<input type="checkbox"/> OFF
WWAN Up	<input type="checkbox"/> OFF
WWAN Down	<input type="checkbox"/> OFF
IPSec Connection Up	<input type="checkbox"/> OFF
IPSec Connection Down	<input type="checkbox"/> OFF
OpenVPN Connection Up	<input type="checkbox"/> OFF
OpenVPN Connection Down	<input type="checkbox"/> OFF
LAN Port Link Up	<input type="checkbox"/> OFF
LAN Port Link Down	<input type="checkbox"/> OFF
USB Device Connect	<input type="checkbox"/> OFF
USB Device Remove	<input type="checkbox"/> OFF
DDNS Update Success	<input type="checkbox"/> OFF
DDNS Update Fail	<input type="checkbox"/> OFF
Received SMS	<input type="checkbox"/> OFF
SMS Command Execute	<input type="checkbox"/> OFF
DI 1 ON	<input type="checkbox"/> OFF
DI 1 OFF	<input type="checkbox"/> OFF
DI 1 Counter Overflow	<input type="checkbox"/> OFF
AI voltage low	<input type="checkbox"/> OFF
AI voltage high	<input type="checkbox"/> OFF
AI current low	<input type="checkbox"/> OFF
AI current high	<input type="checkbox"/> OFF

General Settings @ Notification		
Item	Description	Default
Index	Indicate the ordinal of the list.	--
Description	Enter a description for this group.	Null
Sent SMS	Click the toggle button to enable/disable this option. When enabled, the router will send notification to the specified phone numbers via SMS if event occurs. Set the related phone number in "4.5.4 Services > SMS", and use ';' to separate each number.	OFF
Phone Number	Enter the phone numbers used for receiving event notification. Use a semicolon (;) to separate each number.	Null
Send Email	Click the toggle button to enable/disable this option. When enabled, the router will send notification to the specified email box via Email if event occurs. Set the related email address in "4.5.4 Services > Email".	OFF
Email Addresses	Enter the email addresses used for receiving event notification. Use a space to separate each address.	Null
DO Control	Click the toggle button to enable / disable this option. After opening, DO output is triggered.	OFF
Save to NVM	Click the toggle button to enable/disable this option. Enable to save event to nonvolatile memory.	OFF

In the following window you can query various types of events record. Click **Refresh** to query filtered events while click **Clear** to clear the event records in the window.

Event
Notification
Query

^ Event Details

Save Position

Filtering

```

Apr 18 16:04:00, configuration change, via web manager
Apr 18 15:57:05, configuration change, via web manager
Apr 18 15:57:58, configuration change, via web manager
Apr 18 16:04:59, configuration change, via web manager
Apr 18 16:05:37, configuration change, via web manager
Apr 18 16:05:46, configuration change, via web manager
Apr 18 16:05:52, configuration change, via web manager
Apr 18 16:06:05, USB device remove
Apr 18 16:06:11, USB device connect
Apr 18 16:06:20, USB device remove
Apr 18 16:06:28, configuration change, via web manager
Apr 18 16:06:34, configuration change, via web manager
Apr 18 16:06:40, system time update
Apr 18 16:06:47, configuration change, via web manager
Apr 18 16:07:05, USB device connect
Apr 18 16:07:16, USB device remove
Apr 18 16:07:27, configuration change, via web manager
Apr 18 16:07:51, configuration change, via web manager
Apr 18 16:08:17, configuration change, via web manager
Apr 18 16:09:02, configuration change, via web manager
Apr 18 16:09:20, USB device connect
Apr 18 16:09:44, USB device remove
Apr 18 16:11:01, configuration change, via web manager
Apr 18 16:11:14, USB device connect
Apr 18 16:11:21, USB device remove
Apr 18 16:11:29, configuration change, via web manager
Apr 18 16:11:34, configuration change, via web manager
Apr 18 16:11:35, system time update
                    
```

Clear Refresh

Event Details		
Item	Description	Default
Save Position	Select the events' save position from "RAM" or "NVM". <ul style="list-style-type: none"> RAM: Random-access memory NVM: Non-Volatile Memory 	RAM
Filter Message	Event will be filtered according to the Filter Message that the user set. Click the Refresh button, the filtered event will be displayed in the follow box. Use "&" to separate more than one filter message, such as message1&message2.	Null

4.5.3 NTP

This section allows you to set the related NTP (Network Time Protocol) parameters, including Time zone, NTP Client and NTP Server.

NTP

Status

^ Timezone Settings

Time Zone

Expert Setting

^ NTP Client Settings

Enable ON OFF

Primary NTP Server

Secondary NTP Server

NTP Update Interval

^ NTP Server Settings

Enable ON OFF

NTP		
Item	Description	Default
Timezone Settings		
Time Zone	Click the drop down list to select the time zone you are in. EG, China: UTC + 08:00.	UTC +08:00
Expert Setting	Specify the time zone with Daylight Saving Time in TZ environment variable format. The Time Zone option will be ignored in this case. Eg, "~".	Null
NTP Client Settings		
Enable	Click the toggle button to enable/disable this option. Enable to synchronize time with the NTP server.	ON
Primary NTP Server	Enter primary NTP Server's IP address or domain name.	pool.ntp.org
Secondary NTP Server	Enter secondary NTP Server's IP address or domain name.	Null
NTP Update interval	Enter the interval (minutes) which NTP client synchronize the time from NTP server. Minutes wait for next update, and 0 means update only	0

	once.	
NTP Server Settings		
Enable	Click the toggle button to enable the NTP server option. Once enabled, the NTP client can synchronize with the router in time.	OFF

This window allows you to view the current time of router and also synchronize the router time. Click **Sync** button to synchronize the router time with PC's.

The screenshot shows the NTP configuration page. At the top, there are tabs for 'NTP' and 'Status'. Below the tabs is a section titled '^ Time'. It contains three rows of information: 'System Time' with the value '2018-04-18 16:15:12', 'PC Time' with the value '2018-04-18 16:16:37' and a 'Sync' button to its right, and 'Last Update Time' with the value '2018-04-18 16:11:35'.

4.5.4 SMS

This section allows you to set SMS parameters. Router supports SMS management, and user can control and configure their routers by sending SMS. For more details about SMS control, refer to **5.2.2 SMS Remote Control**.

The screenshot shows the 'SMS Management Settings' page. It has tabs for 'SMS' and 'SMS Testing'. The main section is titled '^ SMS Management Settings'. It contains three settings: 'Enable' with a toggle switch set to 'ON', 'Authentication Type' with a dropdown menu set to 'Password' and a help icon, and 'Phone Number' with an empty input field and a help icon.

SMS Management Settings		
Item	Description	Default
Enable	Click the toggle button to enable/disable the SMS Management option. Note: If this option is disabled, the SMS configuration is invalid.	ON
Authentication Type	Select Authentication Type from “Password”, “Phonenum” or “Both”. <ul style="list-style-type: none"> Password: Use the same username and password as WEB manager for authentication. For example, the format of the SMS should be “username: password; cmd1; cmd2; ...” Note: Set the WEB manager password in System > User Management section. Phonenumber: Use the Phone number for authenticating, and user should set the Phone Number that is allowed for SMS management. The format of the SMS should be “cmd1; cmd2; ...” Both: Use both the “Password” and “Phonenum” for authentication. User should set the Phone Number that is allowed for SMS management. The format of the SMS should be “username: password; cmd1; cmd2; ...” 	Password
Phone Number	Set the phone number used for SMS management, and use ‘;’ to separate each number. Note: It can be null when choose “Password” as the authentication type.	Null

User can test the current SMS service whether it is available in this section.

SMS
SMS Testing

^ SMS Testing

Phone Number

Message

Result

SMS Testing		
Item	Description	Default
Phone Number	Enter the specified phone number which can receive the SMS from router.	Null
Message	Enter the message that router will send it to the specified phone number.	Null
Result	The result of the SMS test will be displayed in the result box.	Null
<input type="button" value="Send"/>	Click the button to send the test message.	--

4.5.5 Email

Email function supports to send the event notifications to the specified recipient by ways of email.

Email

^ Email Settings

Enable ON OFF

Enable TLS/SSL ON OFF ?

Enable STARTTLS ON OFF

Outgoing Server

Server Port

Timeout ?

Auth Login ON OFF ?

Username

Password

From

Subject

Email Settings		
Item	Description	Default
Enable	Click the toggle button to enable/disable the Email option.	OFF
Enable TLS/SSL	Click the toggle button to enable/disable the TLS/SSL option.	OFF
Enable STARTTLS	Click the toggle button to enable/disable the STARTTLS encrypted transmission method.	OFF
Outgoing server	Enter the SMTP server IP Address or domain name.	Null
Server port	Enter the SMTP server port.	25
Timeout	Set the max time for sending email to SMTP server. When the server doesn't receive the email over this time, it will try to resend.	10
Auth Login	Use username and password authentication	OFF
Username	Enter the username which has been registered from SMTP server.	Null
Password	Enter the password of the username above.	Null
From	Enter the source address of the email.	Null
Subject	Enter the subject of this email.	Null

4.5.6 DDNS

This section allows you to set the DDNS parameters. DDNS, the full name of dynamic domain name server, is the dynamic domain name service. DDNS service allows you to map a dynamic IP address to a fixed domain name resolution service. Each time a user connects to the network, the client program will transmit the dynamic IP address of the host to the server program located on the server host. The server program is responsible for providing DNS service and realizing dynamic domain name resolution, that is, DDNS service allows you to provide dynamic w for the host An IP assigns a fixed domain name, and other users can access your host directly through this fixed domain name, rather than through the dynamic Wan IP address. The router's dynamic Wan IP address is assigned directly by the ISP.

Click **Service > DDNS** to set the parameters related to DDNS. and its service provider defaults to DynDNS.



DDNS Status

^ DDNS Settings

Enable ON OFF

Service Provider

Hostname

Username

Password

When service provider chose "Custom", the window is displayed as below.

^ **DDNS Settings**

Enable ON OFF

Service Provider

URL

DDNS Settings		
Item	Description	Default
Enable	Click the toggle button to enable/disable the DDNS option.	OFF
Service Provider	Select the DDNS service from “DynDNS”, “NO-IP”, “3322” or “Custom”. Note: the DDNS service only can be used after registered by Corresponding service provider.	DynDNS
Hostname	Enter the hostname provided by the DDNS server.	Null
Username	Enter the username provided by the DDNS server.	Null
Password	Enter the password provided by the DDNS server.	Null
URL	Enter the URL customized by user.	Null

Click “Status” bar to view the status of the DDNS.

DDNS
Status

^ **DDNS Status**

Status Disabled

Last Update Time

DDNS Status	
Item	Description
Status	Display the current status of the DDNS.
Last Update Time	Display the date and time for the DDNS was last updated successfully.

4.5.7 SSH

Router supports SSH password access and secret-key access.

SSH
Keys Management

^ **SSH Settings**

Enable ON OFF

Port

Disable Password Logins ON OFF

SSH Settings

Item	Description	Default
Enable	Click the toggle button to enable/disable this option. When enabled, you can access the router via SSH.	OFF
Port	Set the port of the SSH access.	22
Disable Password Logins	Click the toggle button to enable/disable this option. When enabled, you cannot use username and password to access the router via SSH. In this case, only the key can be used for login.	OFF

SSH
Keys Management

^ **Import Authorized Keys**

Authorized Keys

No file chosen

Import Authorized Keys	
Item	Description
Authorized Keys	Click on “Choose File” to locate an authorized key from your computer, and then click “Import” to import this key into your router. Note: This option is valid when enabling the password logins option.

4.5.8 GPS (Optional)

This section allows you to configure the GPS parameters. The GPS function of the router can locate and obtain the location information of the device and report it to the designated server. R1520 does not have an independent GPS module. The positioning data comes from the cellular module. Whether the GPS function is supported depends on the cellular module.

GPS
Status
Map

^ **General Settings**

Enable GPS

Sync GPS Time

^ **RS232 Report Settings**

Report to RS232

Report GGA Sentence

Report VTG Sentence

Report RMC Sentence

Report GSV Sentence

^ **GPS Servers**

Index	Enable	Protocol	Local Address	Local Port	Server Address	Server Port	+

^ **Advanced Settings**

Add SN as GPSID
 ?

Self-define GPSID Prefix
 ?

GPS		
Item	Description	Default
General Settings		
Enable	Click the toggle button to ON to enable GPS.	OFF
Synchronized GPS Time	Click the toggle button to ON to synchronize GPS time.	OFF
RS232 Report Data Settings		
Reporting data through RS232	Reporting GPS Information by RS232.	OFF
Reporting GGA Information	Reporting GGA Information.	OFF
Reporting VTG Information	Reporting VTG Information.	OFF
Reporting RMC Information	Reporting RMC Information.	OFF
Reporting GSV Information	Reporting GSV Information.	OFF

Click the Add button in the GPS server window, and its protocol is "TCP client" by default as shown below:

GPS

^ Server Settings

Index

Enable ON OFF

Protocol v

Server Address

Server Port

Send GGA Sentence ON OFF

Send VTG Sentence ON OFF

Send RMC Sentence ON OFF

Send GSV Sentence ON OFF

When "TCP server" is selected as the protocol, the window is displayed as follows:

GPS

^ Server Settings

Index

Enable ON OFF

Protocol v

Local Address

Local Port

Send GGA Sentence ON OFF

Send VTG Sentence ON OFF

Send RMC Sentence ON OFF

Send GSV Sentence ON OFF

When "UDP" is selected as the protocol, the window is displayed as follows:

GPS

^ Server Settings

Index

Enable ON OFF

Protocol v

Server Address

Server Port

Send GGA Sentence ON OFF

Send VTG Sentence ON OFF

Send RMC Sentence ON OFF

Send GSV Sentence ON OFF

GPS Data Forwarding Settings		
Item	Description	Default
Index	Indicate the ordinal of the list.	--
Enable	Click the toggle button to "ON" to enable the GPS data forwarding settings.	ON
Protocol	Select "TCP client", "TCP server" or "UDP" as the protocol. <ul style="list-style-type: none"> TCP Client: When the router acts as a TCP client, it starts up with the TCP server (GPS server). The address of the server supports both IP and domain name. TCP server: The router acts as a TCP server (GPS server) and listens for connection requests from TCP clients. UDP: Router as a UDP client. 	TCP Client

GPS Data Forwarding Settings		
Item	Description	Default
Server address @TCP client	Set the address of the TCP server.	Null
Server port @TCP client	Set the port of the remote TCP server	Null
Local address	Set the local address of the router as a TCP server.	Null
Local port	Set the local port of the router as a TCP server.	Null
Server address @UDP	Set the address of the TCP server	Null
Server port @UDP	Set the port of the remote TCP server.	Null
Send GGA information	Send GGA information in NMEA format	OFF
Send VTG information	Send VTG information in NMEA format	OFF
Send RMC information	Send RMC information in NMEA format	OFF
Send GSV information	Send GSV information in NMEA format	OFF

^ Advanced Settings

Add SN as GPSID ON OFF ?

Self-define GPSID Prefix ?

Advanced Settings		
Item	Description	Default
Add SN as GPSID	Click the switch button to enable/disable this option. When enabled, SN is appended to the NMEA message as a GPSID before transmission.	OFF
Self-define GPSID Prefix	Customize the GPSID prefix with four uppercase letters	Null

Click the "Status" column to view the current GPS status of the gateway;

GPS
Status
Map

^ GPS Status

Status	Not Fixed
UTC Time	2017-09-15 07:18:23
Last Fixed Time	2017-09-14 12:36:58 UTC
Satellites In Use	4
Satellites In View	12
Latitude	23.1534988
Longitude	113.4013826
Altitude	29.0 m
Speed	1.947 m/s

GPS Status	
Item	Description
Status	Shows the current GPS status of the router.
UTC	Shows the UTC of satellite. Note: UTC is the world's unified time, not local time.
Final positioning time	The time of the last successful positioning.
Number of satellites used	Number of satellites used
Number of visible satellites	Number of visible satellites
Latitude	Shows the Latitude information of the router.
Longitude	Shows the longitude information of the router.
Height	Shows the height information of the router.
Speed	Shows the speed information of the router.

Click the "Map" bar to view the current geographic positioning of the gateway.

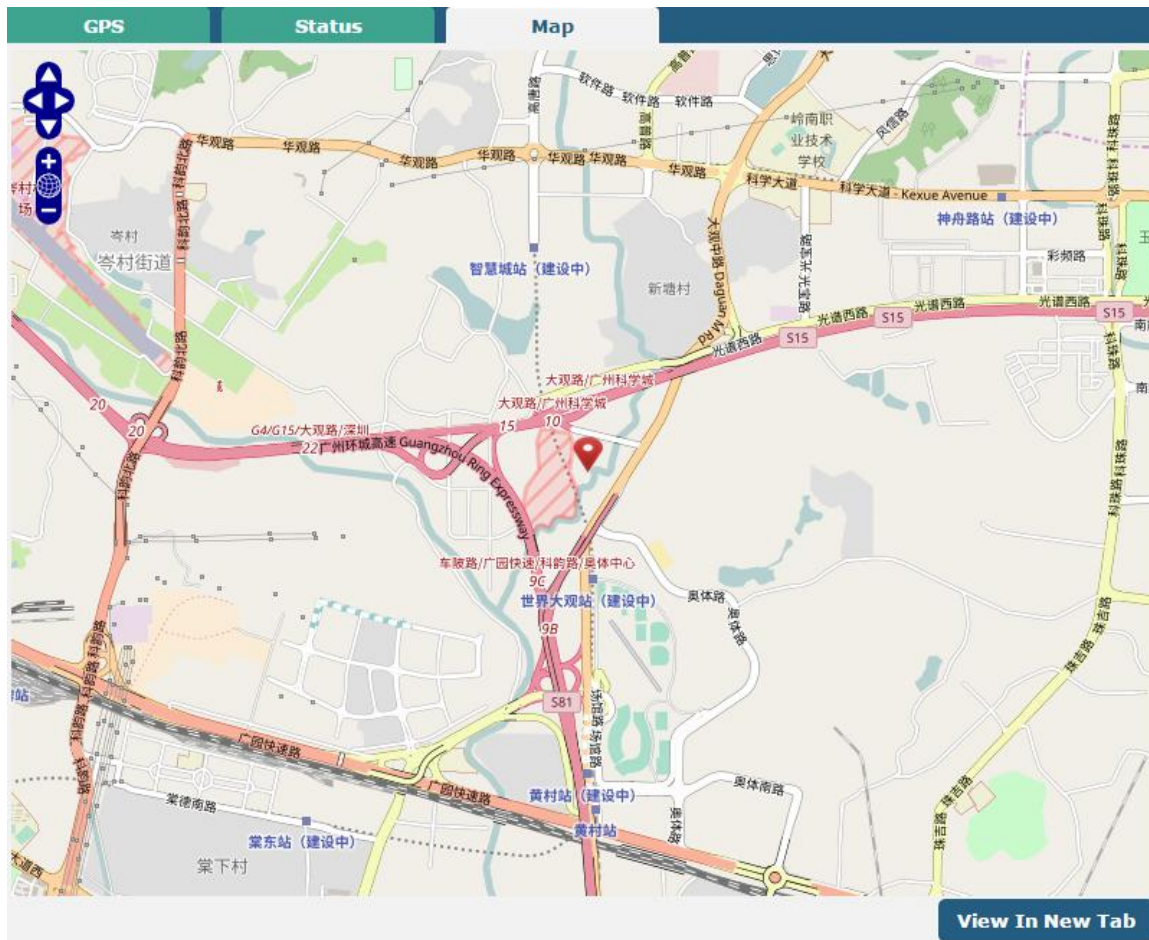

4.5.9 Web Server

This section allows you to modify the parameters of Web Server.

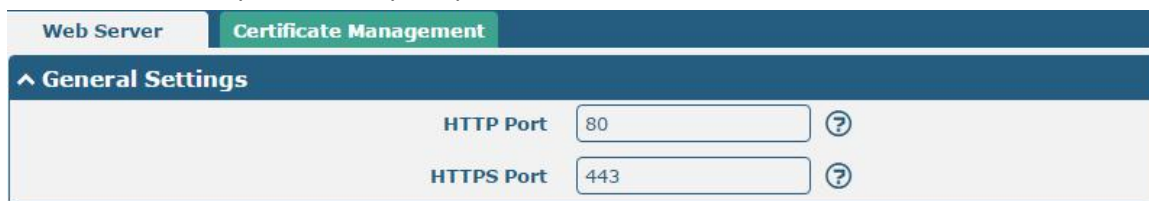

General Settings @ Web Server		
Item	Description	Default
HTTP Port	Enter the HTTP port number you want to change in router's Web Server. On a Web server, port 80 is the port that the server "listens to" or expects to receive from a Web client. If you configure the router with other HTTP Port number except 80, only adding that port number then you can login router's Web Server.	80
HTTPS Port	Enter the HTTPS port number you want to change in router's Web Server. On a	443

	<p>Web server, port 443 is the port that the server "listens to" or expects to receive from a Web client. If you configure the router with other HTTPS Port number except 443, only adding that port number then you can login router's Web Server.</p> <p>Note: HTTPS is more secure than HTTP. In many cases, clients may be exchanging confidential information with a server, which needs to be secured in order to prevent unauthorized access. For this reason, HTTP was developed by Netscape corporation to allow authorization and secured transactions.</p>	
--	--	--

This section allows you to import the certificate file into the router.

Import Certificate		
Item	Description	Default
Import Type	Select from "CA" and "Private Key". <ul style="list-style-type: none"> CA: a digital certificate issued by CA center Private Key: a private key file 	CA
HTTPS Certificate	Click on "Choose File" to locate the certificate file from your computer, and then click "Import" to import this file into your router.	--

4.5.10 Advanced

This section allows you to set the Advanced and parameters. Advanced router settings include system settings and restart.

System Settings		
Item	Description	Default
Device Name	Set the device name to distinguish different devices you have installed; valid characters are a-z, A-Z, 0-9, @, ., -, #, \$, and *.	router
User LED Type	Specify the display type of your USR LED. Select from "None", "OpenVPN" or "IPsec". <ul style="list-style-type: none"> None: Meaningless indication, and the LED is off SIM: show the sim status. OpenVPN: USR indicator showing the OpenVPN status IPsec: USR indicator showing the IPsec status Note: For more details about USR indicator, see "2.2 LED Indicators".	None

System
Reboot

^ Periodic Reboot Settings

Periodic Reboot ?

Daily Reboot Time ?

Reboot		
Item	Description	Default
Periodic Reboot	Set the reboot period of the router. 0 means disable.	0
Daily Reboot Time	Set the daily reboot time of the router, you should follow the format as HH:MM, in 24h time frame, otherwise the data will be invalid. Leave it empty means disable.	Null

4.5.11 Smart Roaming

Smart roaming settings include common settings, health check, Ping settings and advanced settings.

^ General Settings

Smart Roaming Enable ON OFF

General settings		
Item	Description	Default
Enable smart roaming	Click the toggle button to enable/disable the "Smart Roaming" function.	OFF

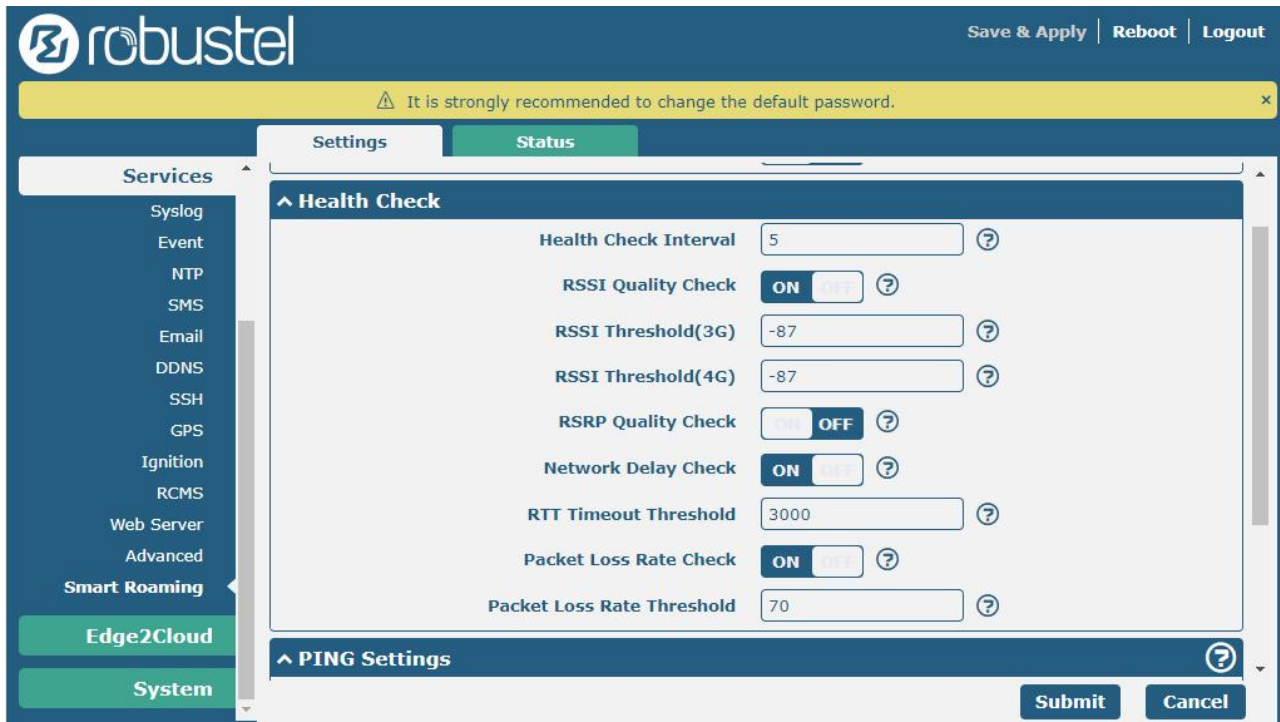

Health check settings

Item	Description	Default
Health check interval	The health check interval of the current connection, in minutes. If the health check fails, Smart Roaming will try to switch to another carrier's network. Be careful not to set all inspection conditions to values that cannot be achieved in theory.	5 minutes
RSSI Quality Check	Click the toggle button to enable/disable the "RSSI Quality Check" function.	ON
RSSI threshold (3G)	The signal strength threshold of the 3G network.	-87 dBm
RSSI threshold (4G)	The signal strength threshold of the 4G network.	-87 dBm
RSRP Quality Check	Click the toggle button to enable/disable the "RSRP Quality Check" function.	OFF
RSRP threshold (4G)	The reference signal received power threshold of the 4G network.	-105 dBm
RSRP threshold (5G)	The reference signal received power threshold of the 5G network.	-105 dBm
Network Delay Check	Click the toggle button to enable/disable the "Network Delay Check" function.	ON
RTT timeout threshold	Round trip timeout time 3000 ms	3000 ms
Packet loss rate check	Click the toggle button to enable/disable the "Packet Loss Rate Check" function.	ON
Packet loss rate threshold	Packet loss rate threshold	70 %

^ PING Settings
?

Primary Server

Secondary Server

PING Timeout ?

Ping Tries ?

PING setting		
Item	Description	Default
Preferred server	The router pings the main address/domain name to check whether the current connection always exists.	8.8.8.8
Standby server	The router pings the alternate address/domain name to check whether the current connection always exists.	114.114.114.114
Ping timeout	Set the timeout period of Ping.	5 seconds
Ping attempts	The number of ping attempts during each health check. Each ping attempt will send 3 ping packets by default, so the total number of ping packets sent during each health check is (3*ping attempts).	3 times

^ Advanced Settings

Use Degraded Network **OFF** ?

Periodic Restart ?

Daily Restart Time ?

Advanced settings		
Item	Description	Default
Use degraded network	Click the toggle button to enable/disable the "Use degraded network" function. The definition of a degraded network is that it can be connected to the Internet, but the network quality does not meet the health check threshold.	OFF
Restart regularly	Set the cycle of restarting the "Smart Roaming" function, in hours. 0 means no periodic restart is enabled. Restarting "Smart Roaming" will re-search for available carrier networks and reset the current status, because searching for available carrier networks takes a long time, and restarting may take 3 to 5 minutes.	0
Restart time every day	Set the time point for restarting "Smart Roaming" every day, the format is HH:MM (24-hour clock). When this item is empty, it means shutting down and restarting.	null

^ Status ?

State Inactive

Operator Selection Mode

Time Since Last Network Scan

Status	
Item	Description
Status	Display the current status of "Smart Roaming". Including Scanning, Connecting, Connected, Inactive and other statuses, respectively indicating that it is searching for available networks, connecting to the network, the network is connected, and the function is not activated.
Operator selection model	Shows the current method of selecting the carrier network. Including Automatic and Manual two methods, respectively refer to the automatic selection according to the standard specification and the software selection according to the network quality, and the software will switch between these two methods in a cycle.
The time elapsed since the last search for available networks	Shows the elapsed time since the last search for available networks. "Smart Roaming" restart will refresh this time.

^ PLMN List ?

Index PLMN Status RAT RSSI(dbm) RSRP(dbm) Latency(ms) Packet Loss(%) HealthCheck

PLMN list	
Item	Description
Index	PLMN list index.
PLMN	PLMN = MCC + MNC, which is the combination of mobile country code and mobile network code.
Status	The current network status, including Current, Visible, Forbidden, Unknown, etc., respectively indicate the current use of this network, available network, forbidden network and unknown network.
RAT	Current wireless access technologies, including 3G/4G/5G.
RSSI	Current signal quality, used in 3G and 4G networks.
RSRP	current reference signal received power, used in 4G and 5G networks. (When connecting to 5G, you cannot see the signal strength RSSI, only the signal power RSRP)
Delay	The current network delay.
Packet loss rate	The current network packet loss rate.
Health check status	The current health check status, including Pending, Good, Degraded, Failed, etc., respectively indicate that the current network has not undergone a health check,

PLMN list	
Item	Description
	the network quality is good, the network is degraded, or the network quality is poor (including network disconnection or failure to meet the health check threshold) .

4.6 System

4.6.1 Debug

This section allows you to check and download the syslog details. Click Service > System Log > System Log Settings to open the system log.

Syslog
?

^ Syslog Details

Log Level

Debug

Filtering

?

```

Feb 27 14:29:07 router user.debug link_manager[842]: target link WWAN1, state Connected
Feb 27 14:29:07 router user.info link_manager[842]: WWAN1 ping test success
Feb 27 14:29:23 router user.debug modemd[876]: +CUSATP:
"D064810301250082028182850F80005500530049004D53615E9475288F0A01807CBE54C163A883508F0A02806C83901A884C8BC18F0A03804FEB6C11670D52A18F0C0480624B673A84254E1A53858F0A05806D4191CF4E13533A8F0A0680727960E0793C5305"
Feb 27 14:31:23 router user.debug modemd[876]: +CUSATP:
"D064810301250082028182850F80005500530049004D53615E9475288F0A01807CBE54C163A883508F0A02806C83901A884C8BC18F0A03804FEB6C11670D52A18F0C0480624B673A84254E1A53858F0A05806D4191CF4E13533A8F0A0680727960E0793C5305"
Feb 27 14:33:23 router user.debug modemd[876]: +CUSATP:
"D064810301250082028182850F80005500530049004D53615E9475288F0A01807CBE54C163A883508F0A02806C83901A884C8BC18F0A03804FEB6C11670D52A18F0C0480624B673A84254E1A53858F0A05806D4191CF4E13533A8F0A0680727960E0793C5305"
Feb 27 14:34:07 router user.debug link_manager[842]: WWAN1 (wwan) start ping test
Feb 27 14:34:07 router user.debug rping[16182]: start ping 8.8.8.8 (wwan)
Feb 27 14:34:07 router user.debug rping[16182]: PING 8.8.8.8 (8.8.8.8) from 10.122.74.11: 16 data bytes
Feb 27 14:34:07 router user.debug rping[16182]: 24 bytes from 8.8.8.8: seq=0 ttl=52 time=324.080 ms
Feb 27 14:34:07 router user.debug rping[16182]:
Feb 27 14:34:07 router user.debug rping[16182]: --- 8.8.8.8 ping statistics ---
Feb 27 14:34:07 router user.debug rping[16182]: 1 packets transmitted, 1 packets received, 0% packet loss
Feb 27 14:34:07 router user.debug rping[16182]: round-trip min/avg/max = 324.080/324.080/324.080 ms
Feb 27 14:34:07 router user.debug link_manager[842]: rcv action ping_success from rping
Feb 27 14:34:07 router user.debug link_manager[842]: target link WWAN1, state Connected
Feb 27 14:34:07 router user.info link_manager[842]: WWAN1 ping test success
Feb 27 14:35:23 router user.debug modemd[876]: +CUSATP:
"D064810301250082028182850F80005500530049004D53615E9475288F0A01807CBE54C163A883508F0A02806C83901A884C8BC18F0A03804FEB6C11670D52A18F0C0480624B673A84254E1A53858F0A05806D4191CF4E13533A8F0A0680727960E0793C5305"
                    
```

Manual Refresh

v

Clear

Refresh

^ Syslog Files

Index	File Name	File Size	Modification Time
1	messages	112612	Mon Feb 27 14:35:23 2017

^ System Diagnostic Data

System Diagnostic Data
Generate

System Diagnostic Data
Download

Syslog

RT056_UG_R1520_v.1.0.3

Dec. 25, 2021

125/159

Item	Description
Syslog Details	
Log Level	Select from “Debug”, “Info”, “Notice”, “Warn”, “Error” which from low to high. The lower level will output more syslog in detail.
Filtering	Enter the filtering message based on the keywords. Use “&” to separate more than one filter message, such as “keyword1&keyword2”.
Refresh	Select from “Manual Refresh”, “5 Seconds”, “10 Seconds”, “20 Seconds” or “30 Seconds”. You can select these intervals to refresh the log information displayed in the follow box. If selecting “manual refresh”, you should click the refresh button to refresh the syslog.
Clear	Click the button to clear the syslog.
Refresh	Click the button to refresh the syslog.
Syslog Files	
Syslog Files List	Only when logging is turned on in Services > system log > system log settings can log files be displayed in this list. The log generates a file with the size of 200K, which can display up to six system log files. Five files named messages0 ~ messages4 are old logs, and the latest system log file messages will be set at the top.
System Diagnosing Data	
Generate	Click to generate the syslog diagnosing file.
Download	Click to download system diagnosing file.

4.6.2 Update

This section allows you to upgrade the firmware of your router. Click **System > Update > System Update**, and click on “Choose File” to locate the firmware file to be used for the upgrade. Once the latest firmware has been chosen, click

Update to start the upgrade process. The upgrade process may take several minutes. Do not turn off your Router during the firmware upgrade process.

Note: To access the latest firmware file, please contact your technical support engineer.



4.6.3 App Center

This section allows you to add some required or customized applications to the router. Import and install your applications to the App Center, and reboot the device according to the system prompts. Each installed application will be displayed under the “Services” menu, while other applications related to VPN will be displayed under the “VPN” menu.

Note: After importing the applications to the router, the page display may have a slight delay due to the browser cache. It is recommended that you clear the browser cache first and log in the router again.



Successfully installed apps will be displayed in the following list, click **X** to uninstall the app.

^ Installed Apps				
Index	Name	Version	Status	Description
1	language_chinese	051101	Stopped	Chinese language X

App Center		
Item	Description	Default
App Install		
Install to SD card	Click the toggle button to enable/disable the ability to install the app to the SD card.	OFF
File	Click on “Choose File” to locate the App file from your computer, and then click Install to import this file into your router. Note: File format should be xxx.rpk.	--
Installed Apps		
Index	Indicate the ordinal of the list.	--
Name	Show the name of the App.	Null
Version	Show the version of the App.	Null
Status	Show the status of the App.	Null
Location	Show the installation path.	Null
Description	Show the description for this App.	Null

4.6.4 Tools

This section provides users three tools: Ping, Traceroute and Sniffer. The Ping tool is used to detect the network connectivity of the router.

Ping
Traceroute
Sniffer

^ Ping

IP Address

Number of Request

Timeout

Local IP

Start
Stop

Ping		
Item	Description	Default
IP address	Enter the ping's destination IP address or destination domain.	Null
Number of Requests	Specify the number of ping requests.	5
Timeout	Specify the timeout of ping request.	1
Local IP	Specify the local IP from cellular WAN, Ethernet WAN or Ethernet LAN. Null stands for selecting local IP address from these three automatically.	Null
Start	Click this button to start ping request, and the log will be displayed in the follow box.	Null
Stop	Click this button to stop ping request.	--

Ping | **Traceroute** | Sniffer

^ Traceroute

Trace Address

Trace Hops

Trace Timeout

Start Stop

Traceroute		
Item	Description	Default
Trace Address	Enter the trace's destination IP address or destination domain.	Null
Trace Hops	Specify the max trace hops. Router will stop tracing if the trace hops has met max value no matter the destination has been reached or not.	30
Trace Timeout	Specify the timeout of Traceroute request.	1
Start	Click this button to start Traceroute request, and the log will be displayed in the follow box.	--
Stop	Click this button to stop Traceroute request.	--

Ping | **Traceroute** | Sniffer

^ Sniffer

Interface

Host

Packets Request

Protocol

Status

Start Stop

^ Capture Files

Index	File Name	File Size	Modification Time
1	18-04-18_16-17-29.cap	24	Wed Apr 18 16:17:30 2018

Sniffer		
Item	Description	Default
Interface	Choose the interface according to your Ethernet configuration.	All
Host	Filter the packet that contain the specify IP address.	Null
Packets Request	Set the packet number that the router can sniffer at a time.	1000
Protocol	Select from "All", "IP", "TCP", "UDP" and "ARP".	All
Port	Set the port number for TCP or UDP that is used in sniffer.	Null
Status	Show the current status of sniffer.	Null
	Click this button to start the sniffer. The grab file will be displayed in the window. Click to download the grab file and click to delete the grab file.	--
	Click this button to stop the sniffer. Once you click this button, a new log file will be displayed in the following List.	--
Capture Files	Every times of sniffer log will be saved automatically as a new file. You can find the file from this Sniffer Traffic Data List and click to download the log, click to delete the log file. It can cache a maximum of 5 files.	Null

4.6.5 Profile

This section allows you to import or export the configuration file, and restore the router to factory default setting.

Profile

Rollback

^ Import Configuration File

Reset Other Settings to Default OFF ?

Ignore Invalid Settings ON ?

XML Configuration File No file chosen **Import**

^ Export Configuration File

Ignore Disabled Features OFF ?

Add Detailed Information OFF ?

Encrypt Secret Data ON ?

XML Configuration File **Generate**

^ Default Configuration

Save Running Configuration as Default **Save** ?

Restore to Default Configuration **Restore**

Profile		
Item	Description	Default
Import Configuration File		
Reset Other Settings to Default	Click the toggle button as "ON" to return other parameters to default settings.	OFF
Ignore Invalid Settings	Click the toggle button as "ON" to ignore invalid settings.	ON

XML Configuration File	Click on Choose File to locate the XML configuration file from your computer, and then click Import to import this file into your router.	--
Export Configuration File		
Ignore Disabled Features	Click the toggle button as "ON" to ignore the disabled features.	OFF
Add Detailed Information	Click the toggle button as "ON" to add detailed information.	OFF
Encrypt Secret Data	Click the toggle button as "ON" to encrypt the secret data.	ON
XML Configuration File	Click Generate button to generate the XML configuration file, and click Export to export the XML configuration file.	--
Default Configuration		
Save Running Configuration as Default	Click Save button to save the current running parameters as default configuration.	--
Restore to Default Configuration	Click Restore button to restore the factory defaults.	--

Profile
Rollback

^ **Configuration Rollback**

Save as a Rollbackable Archive Save ?

^ **Configuration Archive Files**

Index	File Name	File Size	Modification Time

Rollback		
Item	Description	Default
Configuration Rollback		
Save as a Rollbackable Archive	Create a save point manually. Additionally, the system will create a save point every day automatically if configuration changes.	--
Configuration Archive Files		
Configuration Archive Files	View the related information about configuration archive files, including name, size and modification time.	--

4.6.6 User Management

This section allows you to change your username and password, and create or manage user accounts. One router has only one super user who has the highest authority to modify, add and manage other common users.

Note: Your new password must be more than 5 character and less than 32 characters and may contain numbers, upper and lowercase letters, and standard symbols.

Super User

Common User

^ Super User Settings

New Username

?

Old Password

?

New Password

?

Confirm Password

Super User Settings		
Item	Description	Default
New Username	Enter a new username you want to create, If you do not want to change username, leave it blank. 5-32 characters, valid characters: a-z, A-Z, 0-9, @, #, \$, ., *, !, -	Null
Old Password	Enter the old password of your router. The default is "admin", 5-32 characters, valid characters: a-z, A-Z, 0-9, @, #, \$, ., *, !, -	Null
New Password	Enter a new password you want to create, 5-32 characters, valid characters: a-z, A-Z, 0-9, @, #, \$, ., *, !, -	Null
Confirm Password	Enter the new password again to confirm.	Null

Super User

Common User

^ Common User Settings

Index	Role	Username
+		

Click + button to add a new common user. The maximum rule count is 5.

Common User

^ Common Users Settings

Index

Role

v

Username

?

Password

?

Common User Settings		
Item	Description	Default
Index	Indicate the ordinal of the list.	--
Role	Select from "Visitor" and "Editor". <ul style="list-style-type: none"> • Visitor: Users only can view the configuration of router under this level • Editor: Users can view and set the configuration of router under this level 	Visitor
Username	Set the Username, 5-32 characters, valid characters: a-z, A-Z, 0-9, @, #, \$, ., *, !, -	Null
Password	Set the password, 5-32 characters, valid characters: a-z, A-Z, 0-9, @, #, \$, ., *, !, -	Null

4.7 Edge2cloud

4.7.1 Edge2cloud

Edge2Cloud (E2C) is a series of software collections running in the ROS operating system embedded in the Robustel Smart Gateway device, which can provide various functions of the IoT Gateway at the hardware and software levels and solve the problem of data interfacing between traditional industrial device and the cloud platform.

There are three types of E2C: Southbound APP, Northbound APP and Broker.

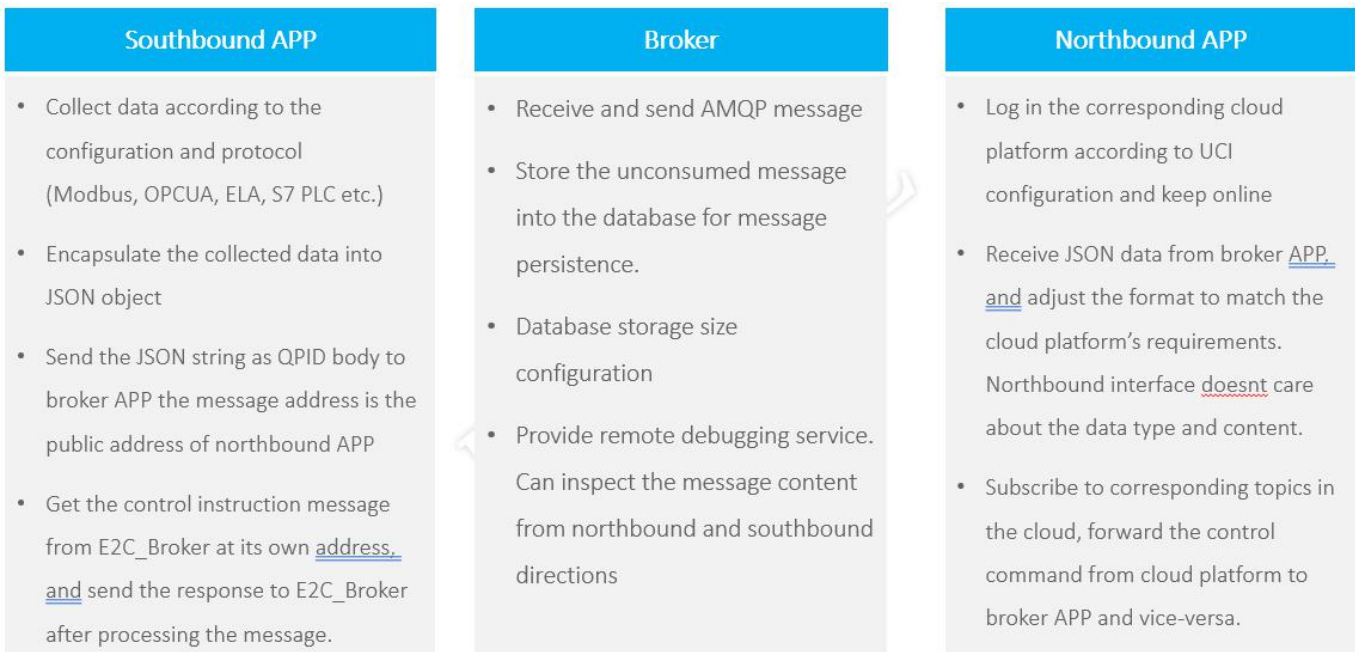

The latest ROS firmware has integrated E2C Broker, users can use the full functionality of E2C by choosing to install the corresponding Southbound APP and Northbound APP according to their needs.

4.7.2 E2C Broker

This section is used to set E2C Broker parameters and view the operational status of E2C Broker. Click "**Edge2Cloud > E2C Broker**" to display the following.

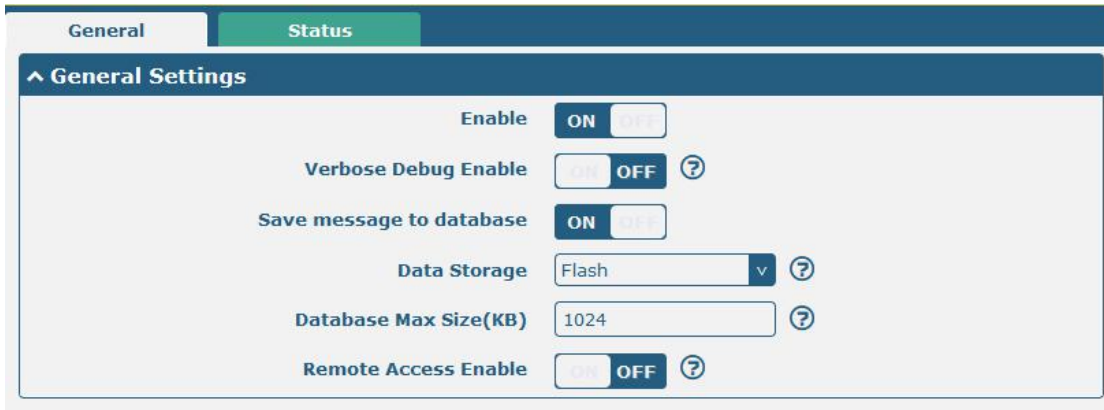

E2C Broker Settings		
Item	Descriptions	Default
General Settings		
Enable	Enable or disable E2C Broker	OFF
Verbose Debug Enable	Enable or disable more detailed verbose debug	OFF
Save message to database	Whether the messages received by Broker are saved to the database.	ON
Data Storage	Database file storage area, optional: RAM, FLASH, SD-Card and USB-Storage.	FLASH
Database Max Size (kB)	The maximum size of the database file, in KB.	1024
Remote Access Enable	Whether to support sending and receiving messages through the web interface.	OFF

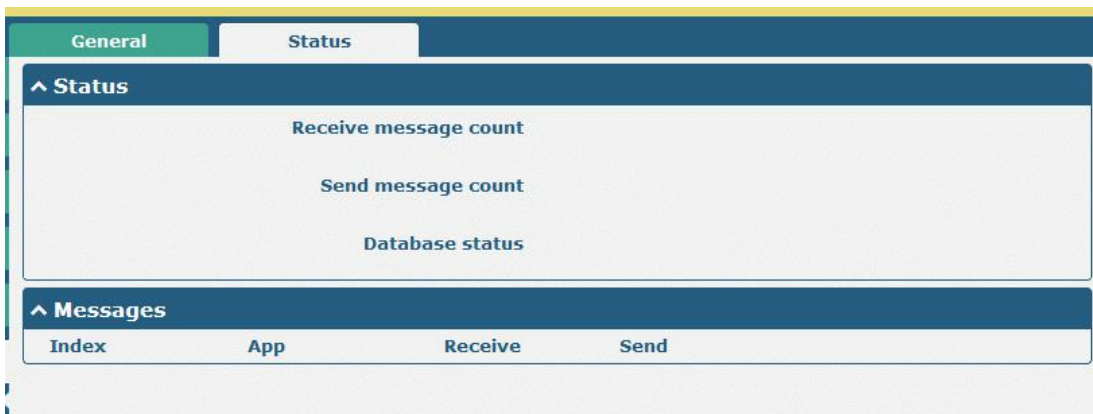

E2C Broker Status	
Item	Descriptions
Status	
Receive message count	The number of MQ messages received by Broker.

E2C Broker Status	
Item	Descriptions
Send message count	Debugging of MQ messages sent by Broker.
Database status	Available means that the database is available and Space exceed means that the database capacity has reached the set maximum.
Messages	
App	Edge2Cloud southbound and northbound app name.
Receive	The number of messages received from the application.
Send	The number of messages sent to the reapplication.

Chapter 5 Configuration Examples

5.1 Cellular

5.1.1 Cellular Dial-Up

This section shows you how to configure the primary and backup SIM card for Cellular Dial-up. Connect the router correctly and insert two SIM, then open the configuration page. Under the homepage menu, click **Interface > Link Manager > Link Manager > General Settings**, choose “WWAN1” as the primary link, “WWAN2” as the backup link and “Cold Backup” as the backup mode then click “Submit”.

Note: In the cold backup mode, when WWAN1 is the primary link, all data will be selected as WWAN1 for transmission, and WWAN2 will always be offline as the backup link; when WWAN1 is disconnected, the data will be switched to WWAN2 for transmission

Link Manager
Status

^ General Settings

Primary Link

WWAN1 v ?

Backup Link

WWAN2 v

Backup Mode

Cold Backup v ?

Revert Interval

0 ?

Emergency Reboot

ON OFF ?

^ Link Settings

Index	Type	Description	Connection Type	
1	WWAN1		DHCP	
2	WWAN2		DHCP	
3	WAN		DHCP	
4	WLAN		DHCP	

Click the right most of edit button of WWAN1 to set its parameters according to the current ISP.

Link Manager

^ General Settings

Index

1

Type

WWAN1 v

Description

^ WWAN Settings

Automatic APN Selection ON OFF

Dialup Number

Authentication Type v

Switch SIM By Data Allowance ON OFF ?

Data Allowance ?

Billing Day ?

^ Ping Detection Settings ?

Enable ON OFF

Primary Server

Secondary Server

Interval ?

Retry Interval ?

Timeout ?

Max Ping Tries ?

^ Advanced Settings

NAT Enable ON OFF

Upload Bandwidth ?

Download Bandwidth

Overridden Primary DNS

Overridden Secondary DNS

Debug Enable ON OFF

Verbose Debug Enable ON OFF

When finished, click **Submit > Save & Apply** for the configuration to take effect.

The window is displayed below by clicking **Interface > Cellular > Advanced Cellular Settings**.

Cellular | **Status** | AT Debug

^ Advanced Cellular Settings

Index	SIM Card	Phone Number	Network Type	Band Select Type	
1	SIM1		Auto	All	
2	SIM2		Auto	All	

Click the right most of edit button of SIM1 to set its parameters according to your application request.

Cellular

^ **General Settings**

Index	<input type="text" value="1"/>
SIM Card	<input type="text" value="SIM1"/> v
Phone Number	<input type="text"/>
PIN Code	<input type="text"/> ?
Extra AT Cmd	<input type="text"/> ?
Telnet Port	<input type="text" value="0"/> ?

^ **Cellular Network Settings**

Network Type	<input type="text" value="Auto"/> v ?
Band Select Type	<input type="text" value="All"/> v ?

^ **Advanced Settings**

Debug Enable	<input type="checkbox"/> ON <input checked="" type="checkbox"/> OFF
Verbose Debug Enable	<input type="checkbox"/> ON <input checked="" type="checkbox"/> OFF

When finished, click **Submit > Save & Apply** for the configuration to take effect.

5.1.2 SMS Remote Control

The router supports remote control via SMS. You can use following commands to get the status of the router, and set all the parameters.

There are three authentication types for SMS control. You can select from "Password", "Phonenum" or "Both".

An SMS command has the following structure:

1. Password mode—**Username:Password;cmd1;cmd2;cmd3;...cmdn** (available for every phone number).
2. Phonenum mode-- **Password;cmd1;cmd2;cmd3;... cmdn** (available when the SMS was sent from the phone number which had been added in R1520's phone group).
3. Both mode-- **Username:Password;cmd1;cmd2;cmd3;...cmdn** (available when the SMS was sent from the phone number).

Note: All command symbols must be entered in the English input half angle mode.

SMS command Explanation:

1. Password: The SMS control password defaults to the login password of the super user or the login password of the ordinary user who has read and write permissions.
2. **cmd1,cmd2,cmd3 to cmdn**, the command format is the same as the CLI command, more details about CLI cmd please refer to **Chapter 6 Introductions for CLI**.

Note: Download the configure XML file from the configured web browser. The format of SMS control command can refer to the data of the XML file.

Go to **System > Profile > Export Configuration File**, Select export type as "complete", click **Generate** to generate the XML file and click **Export** to export the XML file.

Profile	Rollback
^ Import Configuration File	
Reset Other Settings to Default	<input type="checkbox"/> ON <input checked="" type="checkbox"/> OFF ?
Ignore Invalid Settings	<input checked="" type="checkbox"/> ON <input type="checkbox"/> OFF ?
XML Configuration File	<input type="text" value="Choose File"/> No file chosen Import
^ Export Configuration File	
Ignore Disabled Features	<input type="checkbox"/> ON <input checked="" type="checkbox"/> OFF ?
Add Detailed Information	<input type="checkbox"/> ON <input checked="" type="checkbox"/> OFF ?
Encrypt Secret Data	<input checked="" type="checkbox"/> ON <input type="checkbox"/> OFF ?
XML Configuration File	Generate
^ Default Configuration	
Save Running Configuration as Default	Save ?
Restore to Default Configuration	Restore

XML command:

```
<lan>
<network max_entry_num="2">
<id>1</id>
<interface>lan0</interface>
<ip>172.16.24.24</ip>
<netmask>255.255.0.0</netmask>
<mtu>1500</mtu>
```

SMS cmd:

```
set lan network 1 interface lan0
set lan network 1 ip 172.16.24.24
set lan network 1 netmask 255.255.0.0
set lan network 1 mtu 1500
```

3. The semicolon character (;) is used to separate more than one command packed in a single SMS.

4. E.g.

Password mode—**admin:admin;status system**

In this command, username is “admin”, password is “admin”, The control command is status system, and the function of the command is to get the system status.

SMS received:

```
hardware_version = 1.1
firmware_version = 3.1.0
firmware_version_full = "3.1.0 (Rev 3199)"
kernel_version = 4.9.152
device_model = R1520
serial_number = ""
uptime = "0 days, 00:02:55"
```

```
system_time = "Thu May 14 05:51:56 2020 (NTP not updated)"
```

```
ram_usage = "75M Free/128M Total"
```

```
admin:admin;reboot
```

In this command, username is "admin", password is "admin", and the command is to reBoot the R1520 Router.

SMS received:

OK

```
admin:admin;set firewall remote_ssh_access false;set firewall remote_telnet_access false
```

In this command, username is "admin", password is "admin", and the command is to disaBle the remote_ssh and remote_telnet access.

SMS received:

OK

OK

```
admin:admin; set lan network 1 interface lan0;set lan network 1 ip 172.16.24.24;set lan network 1 netmask 255.255.0.0;set lan network 1 mtu 1500
```

In this command, username is "admin", password is "admin", and the commands is to configure the LAN parameter.

SMS received:

OK

OK

OK

OK

5.2 VPN Configuration Example

5.2.1 IPsec VPN

IPSec VPN sample topology (configuration of Ike and SA parameters of server and client must be consistent):

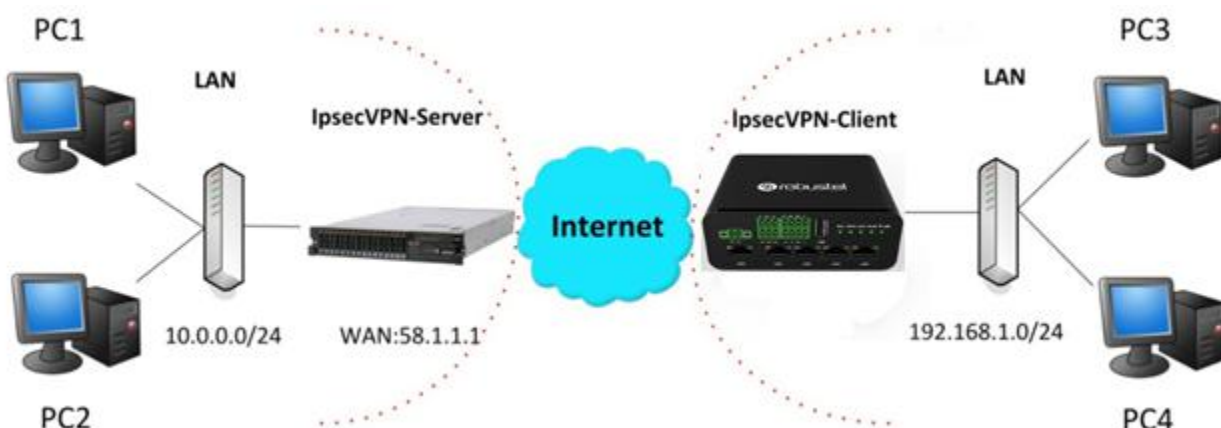

IPsec VPN_Server:

Cisco 2811:

```

Router>enable
Router#config
Configuring from terminal, memory, or network [terminal]?
Enter configuration commands, one per line.  End with CNTL/Z.
Router(config)#crypto isakmp policy 10
Router(config-isakmp)#?
  authentication  Set authentication method for protection suite
  encryption     Set encryption algorithm for protection suite
  exit           Exit from ISAKMP protection suite configuration mode
  group          Set the Diffie-Hellman group
  hash           Set hash algorithm for protection suite
  lifetime       Set lifetime for ISAKMP security association
  no             Negate a command or set its defaults
Router(config-isakmp)#encryption 3des
Router(config-isakmp)#hash md5
Router(config-isakmp)#authentication pre-share
Router(config-isakmp)#group 2
Router(config-isakmp)#exit
Router(config)#crypto isakmp ?
  client  Set client configuration policy
  enable  Enable ISAKMP
  key     Set pre-shared key for remote peer
  policy  Set policy for an ISAKMP protection suite
Router(config)#crypto isakmp key cisco address 0.0.0.0 0.0.0.0

Router(config)#crypto ?
  dynamic-map  Specify a dynamic crypto map template
  ipsec        Configure IPSEC policy
  isakmp       Configure ISAKMP policy
  key          Long term key operations
  map          Enter a crypto map
Router(config)#crypto ipsec ?
  security-association  Security association parameters
  transform-set         Define transform and settings
Router(config)#crypto ipsec transform-set Trans ?
  ah-md5-hmac  AH-HMAC-MD5 transform
  ah-sha-hmac  AH-HMAC-SHA transform
  esp-3des    ESP transform using 3DES(EDE) cipher (168 bits)
  esp-aes     ESP transform using AES cipher
  esp-des     ESP transform using DES cipher (56 bits)
  esp-md5-hmac ESP transform using HMAC-MD5 auth
  esp-sha-hmac ESP transform using HMAC-SHA auth
Router(config)#crypto ipsec transform-set Trans esp-3des esp-md5-hmac

Router(config)#ip access-list extended vpn
Router(config-ext-nacl)#permit ip 10.0.0.0 0.0.0.255 192.168.1.0 0.0.0.255
Router(config-ext-nacl)#exit

Router(config)#crypto map cry-map 10 ipsec-isakmp
% NOTE: This new crypto map will remain disabled until a peer
and a valid access list have been configured.
Router(config-crypto-map)#match address vpn
Router(config-crypto-map)#set transform-set Trans
Router(config-crypto-map)#set peer 202.100.1.1
Router(config-crypto-map)#exit

Router(config)#interface fastEthernet 0/0
Router(config-if)#ip address 58.1.1.1 255.255.255.0
Router(config-if)#cr
Router(config-if)#crypto map cry-map
*Jan 3 07:16:26.785: %CRYPTO-6-ISAKMP_ON_OFF: ISAKMP is ON

```

IPsec VPN_Client:

The window is displayed as below by clicking **VPN > IPsec > Tunnel**.

General	Tunnel	Status	x509			
^ Tunnel Settings						
Index	Enable	Description	Gateway	Local Subnet	Remote Subnet	+

Click **+** button and set the parameters of IPsec Client as below.

Tunnel

^ General Settings

Index

Enable ON OFF

Description

Gateway ?

Mode v

Protocol v

Local Subnet ?

Remote Subnet ?

Link Binding v ?

^ IKE Settings

IKE Type v

Negotiation Mode v

Encryption Algorithm v

Authentication Algorithm v

IKE DH Group v

Authentication Type v

PSK Secret

Local ID Type v

Remote ID Type v

IKE Lifetime ?

^ SA Settings

Encryption Algorithm	<input type="text" value="3DES"/>	v	
Authentication Algorithm	<input type="text" value="SHA1"/>	v	
PFS Group	<input type="text" value="DHgroup2"/>	v	
SA Lifetime	<input type="text" value="28800"/>	?	
DPD Interval	<input type="text" value="30"/>	?	
DPD Failures	<input type="text" value="150"/>	?	

^ Advanced Settings

Enable Compression	<input type="checkbox"/> OFF		
Enable Forceencaps	<input type="checkbox"/> OFF	?	
Expert Options	<input type="text"/>	?	

When finished, click **Submit > Save & Apply** for the configuration to take effect.

The comparison between IPsec Server and Client is as below.

Server (Cisco 2811)

```

Router#enable
Router#config
Configuring from terminal, memory, or network [terminal]
Enter configuration commands, one per line. End with CNTL/Z.
Router(config)#crypto isakmp policy 10
Router(config)#isakmp i17
 authentication Set authentication method for protection suite
 encryption Set encryption algorithm for protection suite
 wait Exit from ISAKMP protection suite configuration mode
 group Set the Diffie-Hellman group
 hash Set hash algorithm for protection suite
 lifetime Set lifetime for ISAKMP security association
 no - Negate a command or set its defaults
Router(config)#crypto isakmp #encryption 3des
Router(config)#crypto isakmp #hash sha1
Router(config)#crypto isakmp #authentication gcm-sha256
Router(config)#crypto isakmp #group 2
Router(config)#crypto isakmp #exit
Router(config)#crypto isakmp 7
 client Set client configuration policy
 enable Enable ISAKMP
 key Set pre-shared key for remote peer
 policy Set policy for an ISAKMP protection suite
 lifetime Set lifetime for ISAKMP security association
Router(config)#crypto isakmp key cisco address 0.0.0.0 0.0.0.0

Router(config)#crypto ?
 dynamic-map Specify a dynamic crypto map template
 ipsec Configure IPSEC policy
 isakmp Configure ISAKMP policy
 key Long term key operations
 map Enter a crypto map
Router(config)#crypto ipsec 7
 security-association Security association parameters
 transform-set Define transform and settings
Router(config)#crypto ipsec transform-set Trans 1
 ah-sha-hmac AH-IPsec-SHA transform
 esp-3des ESP transform using 3DES (EDE) cipher (168 bits)
 esp-aes ESP transform using AES cipher
 esp-des ESP transform using DES cipher (64 bits)
 esp-md5-hmac ESP transform using MD5-HMAC auth
 esp-sha-hmac ESP transform using SHA-HMAC auth
Router(config)#crypto ipsec transform-set Trans esp-3des esp-md5-hmac

Router(config)#ip access-list extended vpn
Router(config-ext-nacl)#permit ip 10.0.0.0 0.0.0.255 192.168.1.0 0.0.0.255
Router(config-ext-nacl)#exit

Router(config)#crypto map cry-map 10 ipsec-isakmp
! NOTE: This new crypto map will remain disabled until a peer
and a valid access list have been configured.
Router(config)#crypto map #match address vpn
Router(config)#crypto map #set transform-set Trans
Router(config)#crypto map #set peer 200.100.1.1
Router(config)#crypto map #exit

Router(config)#interface fastEthernet 0/0
Router(config-if)#ip address 58.1.1.1 255.255.255.0
Router(config-if)#exit
Router(config-if)#crypto map cry-map
*Jan  8 07:16:24.785: NCRYPTO-6-ISAKMP_OK_OFF: ISAKMP is ON
          
```

^ Tunnel Settings

Index	<input type="text" value="1"/>		
Enable	<input checked="" type="checkbox"/>		
Description	<input type="text"/>		
Gateway	<input type="text" value="58.1.1.1"/>	?	
Mode	<input type="text" value="Tunnel"/>	v	
Protocol	<input type="text" value="ESP"/>	v	
Local Subnet	<input type="text" value="192.168.1.0"/>	?	
Remote Subnet	<input type="text" value="255.255.255.0"/>	?	

^ IKE Settings

Negotiation Mode	<input type="text" value="Main"/>		
Authentication Algorithms	<input type="text" value="MD5"/>	v	
Encrypt Algorithms	<input type="text" value="3DES"/>	v	
IKE DH Group	<input type="text" value="MODP(1024)"/>	v	
Authentication Type	<input type="text" value="PSK"/>	v	
PSK Secret	<input type="text" value="*****"/>		
Local ID Type	<input type="text" value="Default"/>	v	
Remote ID Type	<input type="text" value="Default"/>	v	
IKE Lifetime	<input type="text" value="86400"/>	?	

^ SA Settings

Encrypt Algorithms	<input type="text" value="3DES"/>		
Authentication Algorithms	<input type="text" value="MD5"/>	v	
PFS Group	<input type="text" value="MODP(1024)"/>	v	
SA Lifetime	<input type="text" value="28800"/>	?	
DPD Interval	<input type="text" value="60"/>	?	
DPD Failures	<input type="text" value="180"/>	?	

^ Advanced Settings

Enable Compression	<input type="checkbox"/> OFF		
--------------------	------------------------------	--	--

IKE Setting in Client must be consistent with server.

SA Setting in Client must be consistent with server.

RT056_UG_R1520_v.1.0.3

Dec. 25, 2021

143/159

5.2.2 OpenVPN

OpenVPN supports two modes, including Client and P2P. Here takes P2P as an example.

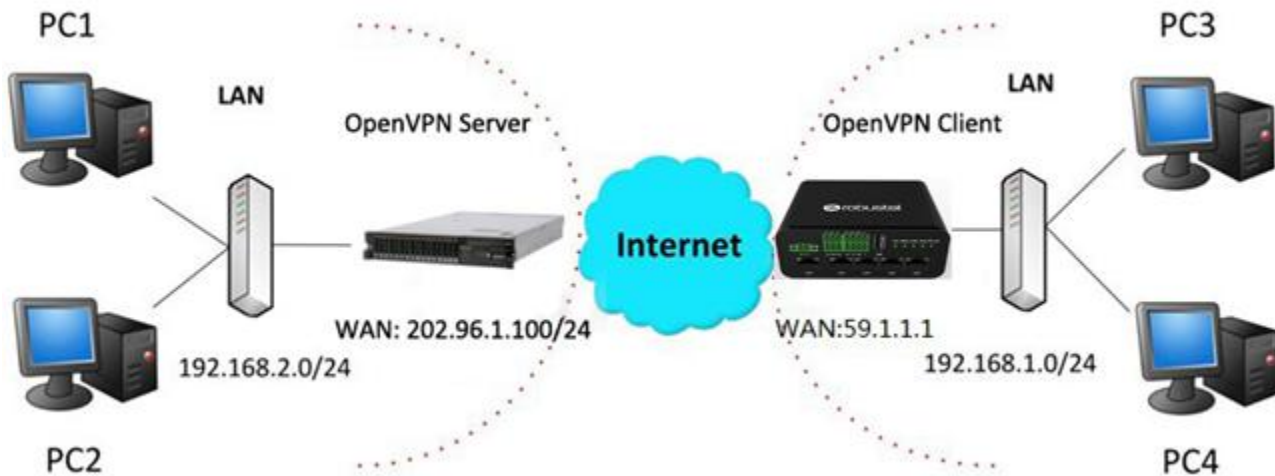

The configuration of two points is as follows.

OpenVPN_Server:

Generate relevant OpenVPN certificate on the server side firstly, and refer to the following commands to configuration the Server:

```
local 202.96.1.100
mode server
port 1194
proto udp
dev tun
tun-mtu 1500
fragment 1500
ca ca.crt
cert Server01.crt
key Server01.key
dh dh1024.pem
server 10.8.0.0 255.255.255.0
ifconfig-pool-persist ipp.txt
push "route 192.168.3.0 255.255.255.0"
client-config-dir ccd
route 192.168.1.0 255.255.255.0
keepalive 10 120
cipher BF-CBC
comp-lzo
max-clients 100
persist-key
persist-tun
status openvpn-status.log
verb 3
```

Note: For more configuration details, please contact your technical support engineer.

OpenVPN_Client:

Click **VPN > OpenVPN > OpenVPN** as below.

OpenVPN	Status	x509					
^ Tunnel Settings							
Index	Enable	Description	Mode	Protocol	Server Address	Interface Type	+

Click **+** to configure the Client01 as below.

^ General Settings

Index	<input type="text" value="1"/>
Enable	<input checked="" type="checkbox"/> ON <input type="checkbox"/> OFF
Description	<input type="text"/>
Mode	<input type="text" value="Client"/> ?
Protocol	<input type="text" value="UDP"/> v
Peer Address	<input type="text"/>
Peer Port	<input type="text" value="1194"/>
Interface Type	<input type="text" value="TUN"/> v
Authentication Type	<input type="text" value="None"/> v ?
Encrypt Algorithm	<input type="text" value="BF"/> v
Authentication Algorithm	<input type="text" value="SHA1"/> v
Renegotiation Interval	<input type="text" value="86400"/> ?
Keepalive Interval	<input type="text" value="20"/> ?
Keepalive Timeout	<input type="text" value="120"/> ?
TUN MTU	<input type="text" value="1500"/>
Max Frame Size	<input type="text"/>
Enable Compression	<input checked="" type="checkbox"/> ON <input type="checkbox"/> OFF
Enable NAT	<input type="checkbox"/> ON <input checked="" type="checkbox"/> OFF
Enable DNS overrid	<input type="checkbox"/> ON <input checked="" type="checkbox"/> OFF ?
Verbose Level	<input type="text" value="0"/> v ?

^ Advanced Settings

Enable HMAC Firewall	<input type="checkbox"/> ON <input checked="" type="checkbox"/> OFF
Enable PKCS#12	<input type="checkbox"/> ON <input checked="" type="checkbox"/> OFF
Enable nsCertType	<input type="checkbox"/> ON <input checked="" type="checkbox"/> OFF
Expert Options	<input type="text"/> ?

When finished, click **Submit > Save & Apply** for the configuration to take effect.

5.2.3 GRE VPN

GRE VPN example topology:

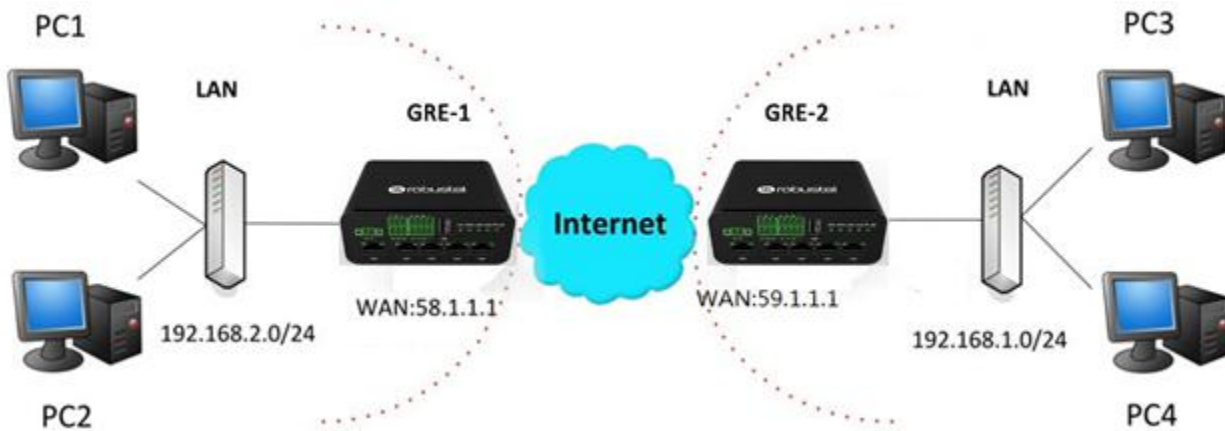

The configuration of two points is as follows.

GRE-1:

The window is displayed as below by clicking **VPN > GRE > GRE**.



Click **+** button and set the parameters of GRE-1 as below.

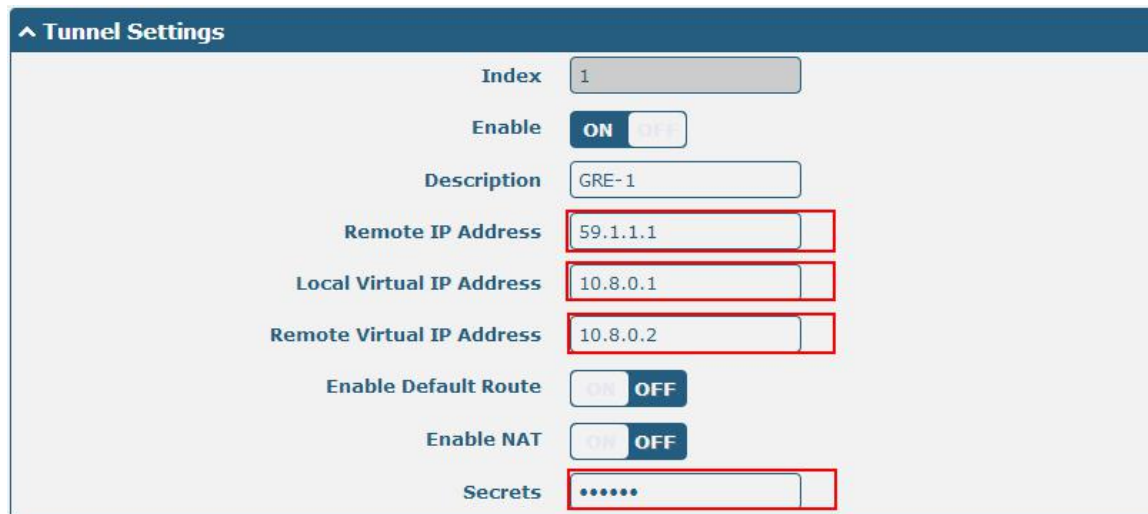

When finished, click **Submit > Save & Apply** for the configuration to take effect.

GRE-2:

Click **+** button and set the parameters of GRE-2 as below.

When finished, click **Submit > Save & Apply** for the configuration to take effect.

The comparison between GRE-1 and GRE-2 is as below.

GRE-1	GRE-2
Index: 1	Index: 1
Enable: ON	Enable: ON
Description: GRE-1	Description: GRE-2
Remote IP Address: 59.1.1.1 (GRE-1 public IP)	Remote IP Address: 58.1.1.1 (GRE-2 public IP)
Local Virtual IP Address: 10.8.0.1 (GRE-1 tunnel IP)	Local Virtual IP Address: 10.8.0.2 (GRE-2 tunnel IP)
Remote Virtual IP Address: 10.8.0.2 (GRE-2 tunnel IP)	Remote Virtual IP Address: 10.8.0.1 (GRE-1 tunnel IP)
Enable Default Route: OFF	Enable Default Route: OFF
Enable NAT: OFF (set the same secret as GRE-2)	Enable NAT: OFF (set the same secret as GRE-1)
Secrets: *****	Secrets: *****

Chapter 6 Introductions for CLI

6.1 What Is CLI

The Command Line Interface (CLI) is a set of software interfaces that provide another way to configure device parameters. Users can connect to the router through SSH or telnet to configure CLI commands. After establishing a Telnet or SSH connection with the router, enter the login account and password (default admin/admin) to enter the router's configuration mode, as shown below.

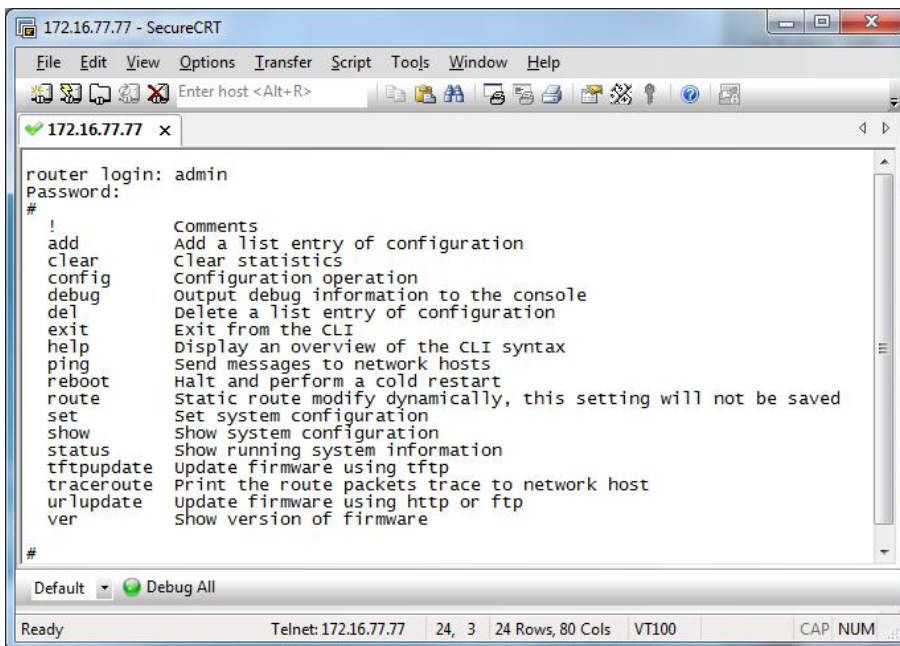

```

172.16.77.77 - SecureCRT
File Edit View Options Transfer Script Tools Window Help
Enter host <Alt+R>
172.16.77.77 x
router login: admin
Password:
#
!           Comments
add         Add a list entry of configuration
clear      Clear statistics
config     Configuration operation
debug     Output debug information to the console
del        Delete a list entry of configuration
exit       Exit from the CLI
help      Display an overview of the CLI syntax
ping      Send messages to network hosts
reboot    Halt and perform a cold restart
route     Static route modify dynamically, this setting will not be saved
set       set system configuration
show      Show system configuration
status    Show running system information
tftpupdate Update firmware using tftp
traceroute Print the route packets trace to network host
urlupdate Update firmware using http or ftp
ver       Show version of firmware
#
Default  Debug All
Ready          Telnet: 172.16.77.77  24, 3  24 Rows, 80 Cols  VT100  CAP NUM

```

Router login:

Router login: admin

Password: admin

#

CLI commands:

? (**Note:** the '?' won't display on the page.)

!	Comments
add	Add a list entry of configuration
clear	Clear statistics
config	Configuration operation
debug	Output debug information to the console
del	Delete a list entry of configuration
exit	Exit from the CLI
help	Display an overview of the CLI syntax
ovpn_cert_get	Download OpenVPN certificate file via http or ftp

ping	Send messages to network hosts
reboot	Halt and perform a cold restart
set	Set system configuration
show	Show system configuration
status	Show running system information
tftpupdate	Update firmware or configuration file using tftp
traceroute	Print the route packets trace to network host
trigger	Trigger action
urlupdate	Update firmware via http or ftp
ver	Show version of firmware

6.2 How to Configure the CLI

Following is a table about the description of help and the error should be encountered in the configuring program.

Commands /tips	Description
?	<p>Typing a question mark “?” will show you the help information.</p> <p>Example:</p> <pre># config (Tick ‘?’) config Configuration operation</pre> <p># config (Tick the space key+’?’)</p> <pre>commit Save the configuration changes and take effect changed configuration save_and_apply Save the configuration changes and take effect changed configuration loaddefault Restore Factory Configuration</pre>
Ctrl+c	Tick these two keys at the same time, except its “copy” function but also can be used for “break” out of the setting program.
Syntax error: The command is not completed	Command is not completed.
Tick space key+ Tab key	<p>It can help you finish your currently incomplete commands.</p> <p>Example:</p> <pre># config (tick Enter key) Syntax error: The command is not completed</pre> <p># config (tick space key+ Tab key)</p> <pre>commit save_and_apply loaddefault</pre>
# config save_and_apply / #config commit	<p>When your setting finished, you should enter those commands to make your setting take effect on the device.</p> <p>Note: Commit and save_and_apply plays the same role.</p>

6.3 Commands Reference

Commands	Syntax	Description
Debug	<i>Debug parameters</i>	enable on or disable the debug function
Show	<i>Show parameters</i>	Show current configuration of each function
Set	<i>Set parameters</i>	All the function parameters are set by commands set and add, the difference is that set is for the single parameter and add is for the list parameter
Add	<i>Add parameters</i>	

Note: More detail about CLI command, please refer to “Command Line Interface Guide”.

6.4 Quick Start with Configuration Examples

The best and quickest way to master CLI is firstly to view all features from the webpage and then read all CLI commands at a time, finally learn to configure it with some reference examples.

Example 1: Show current version

```
# status system
hardware_version = 1.1
firmware_version = 3.1.0
firmware_version_full = "3.1.0 (Rev 3199)"
kernel_version = 4.9.152
device_model = R1520
serial_number = ""
uptime = "0 days, 00:06:51"
system_time = "Thu May 14 05:55:52 2020 (NTP not updated)"
ram_usage = "74M Free/128M Total"
```

Example 2: Update firmware via tftp

```
# tftpupdate (space+?)
firmware New firmware
# tftpupdate firmware (space+?)
String Firmware name
# tftpupdate firmware r1520-firmware-3.1.0.ruf host 192.168.100.99 // enter a new firmware name
Downloading
r1520-firmware-s 100% |*****| 5018k 0: 00: 00 ETA
Flashing
Checking 100%
Decrypting 100%
Flashing 100%
Verifying 100%
Verify Success
upgrade success // update success
# config save_and_apply
OK // make you configuration effect after reboot
```

Example 3: Set link-manager

```
# set
# set (space+?)
ai AI
cellular Cellular
```

ddns	DDNS
dido	DIDO
email	Email
ethernet	Ethernet
event	Event Management
firewall	Firewall
gps	GPS
gre	GRE
ip_passthrough	IP Passthrough
ipsec	IPSec
lan	Local Area Network
link_manager	Link Manager
ntp	NTP
openvpn	OpenVPN
reboot	Automatic Reboot
route	Route
serial_port	Serial Port
sms	SMS
ssh	SSH
syslog	Syslog
system	System
usb	USB
user_management	User Management
web_server	Web Server
wifi	WiFi AP
# set link_management	
primary_link	Primary Link
Backup_link	Backup Link
Backup_mode	BackSup Mode
emergency_reBoot	Emergency ReBoot
link	Link Settings
# set link_management primary_link (space+?)	
Enum	Primary Link (wwan1/wwan2/wan/wlan)
# set link_management primary_link wwan1	//select "wwan1" as primary link
OK	//setting succeed
set link_manager link 1	
type	Type
desc	Description
connection_type	Connection Type
wwan	WWAN Settings
static_addr	Static Address Settings
pppoe	PPPoE Settings
ping	Ping Settings
mtu	MTU
dns1_overrided	Overrided Primary DNS
dns2_overrided	Overrided Secondary DNS

```
# set link_manager link 1 type wwan1
OK
# set link_manager link 1 wwan
  auto_apn           Automatic APN Selection
  apn                APN
  username           Username
  password           Password
  dialup_numBer     Dialup NumBer
  auth_type          Authentication Type
  aggressive_reset   Aggressive Reset
  switch_By_data_allowance Switch SIM By Data Allowance
  data_allowance     Data Allowance
  Billing_day         Billing Day
# set link_manager link 1 wwan switch_By_data_allowance true
OK
#
# set link_manager link 1 wwan data_allowance 100           //open cellular switch_by_data_traffic
OK                                                         //setting succeed
# set link_manager link 1 wwan Billing_day 1                 //setting specifies the day of month for billing
OK                                                         //setting succeed
...
# config save_and_apply
OK                                                         //save and apply current configuration, make you configuration effect
```

Example 4: Set Ethernet

```
# set Ethernet port_setting 2 port_assignment lan0           //Set Table 2 (eth1) to lan0
OK
# config save_and_apply           //make you configuration effect
OK
```

Example 5: Set LAN IP address

```
# show lan all
network {
  id = 1
  interface = lan0
  ip = 192.168.0.1
  netmask = 255.255.255.0
  mtu = 1500
  dhcp {
```

```

        umber = true
        mode = server
        relay_server = ""
        pool_start = 192.168.0.2
        pool_end = 192.168.0.100
        netmask = 255.255.255.0
        gateway = ""
        primary_dns = ""
        secondary_dns = ""
        wins_server = ""
        lease_time = 120
        expert_options = ""
        umbe_enaBle = false
    }
}
multi_ip {
    id = 1
    interface = lan0
    ip = 172.16.24.24
    netmask = 255.255.0.0
}
#
# set lan
network      Network Settings
multi_ip     Multiple IP Address Settings
vlan         VLAN
# set lan network 1(space+?)
interface    Interface
ip           IP Address
netmask      Netmask
mtu          MTU
dhcp         DHCP Settings
# set lan network 1 interface lan0
OK
# set lan network 1 ip 172.16.24.24           //set IP address for lan
OK                                             //setting succeed
# set lan network 1 netmask 255.255.0.0
OK
#
...
# config save_and_apply
OK                                             //save and apply current configuration, make you configuration
effect

```

Example 6: CLI for setting Cellular

```
# show cellular all
sim {
    id = 1
    card = sim1
    phone_numBer = ""
    extra_at_cmd = ""
    network_type = auto
    Band_select_type = all
    Band_gsm_850 = false
    Band_gsm_900 = false
    Band_gsm_1800 = false
    Band_gsm_1900 = false
    Band_wcdma_850 = false
    Band_wcdma_900 = false
    Band_wcdma_1900 = false
    Band_wcdma_2100 = false
    Band_lte_800 = false
    Band_lte_850 = false
    Band_lte_900 = false
    Band_lte_1800 = false
    Band_lte_1900 = false
    Band_lte_2100 = false
    Band_lte_2600 = false
    Band_lte_1700 = false
    Band_lte_700 = false
    Band_tdd_lte_2600 = false
    Band_tdd_lte_1900 = false
    Band_tdd_lte_2300 = false
    Band_tdd_lte_2500 = false
}
sim {
    id = 2
    card = sim2
    phone_numBer = ""
    extra_at_cmd = ""
    network_type = auto
    Band_select_type = all
    Band_gsm_850 = false
    Band_gsm_900 = false
    Band_gsm_1800 = false
    Band_gsm_1900 = false
    Band_wcdma_850 = false
    Band_wcdma_900 = false
    Band_wcdma_1900 = false
```

```
Band_wcdma_2100 = false
Band_lte_800 = false
Band_lte_850 = false
Band_lte_900 = false
Band_lte_1800 = false
Band_lte_1900 = false
Band_lte_2100 = false
Band_lte_2600 = false
Band_lte_1700 = false
Band_lte_700 = false
Band_tdd_lte_2600 = false
Band_tdd_lte_1900 = false
Band_tdd_lte_2300 = false
Band_tdd_lte_2500 = false
}
# set(space+?)
ai          AI
cellular    Cellular
ddns        DDNS
dido        DIDO
email       Email
ethernet    Ethernet
event       Event Management
firewall    Firewall
gps         GPS
gre         GRE
ip_passthrough IP Passthrough
ipsec       IPsec
lan         Local Area Network
link_manager Link Manager
ntp         NTP
openvpn     OpenVPN
reboot      Automatic Reboot
route       Route
serial_port Serial Port
sms         SMS
ssh         SSH
syslog      Syslog
system      System
usb         USB
user_management User Management
web_server  Web Server
wifi        WiFi AP
# set cellular(space+?)
sim  SIM Settings
# set cellular sim(space+?)
```

Integer Index (1..2)

```
# set cellular sim 1(space+?)
```

```
card                SIM Card
phone_number        Phone Number
pin_code            PIN Code
extra_at_cmd        Extra AT Cmd
telnet_port         Telnet Port
network_type        Network Type
band_select_type    Band Select Type
band_settings       Band Settings
telit_band_settings Band Settings
debug_enable        Debug Enable
verbose_debug_enable Verbose Debug Enable
```

```
# set cellular sim 1 phone_number 18620435279
```

```
OK
```

```
...
```

```
# config save_and_apply
```

```
OK // save and apply current configuration, make you configuration eff
```

Glossary

Abbr.	Description
AC	Alternating Current
AI	Analog Input
APN	Access Point Name of GPRS Service Provider Network
ASCII	American Standard Code for Information Interchange
CE	Conformité Européene (European Conformity)
CHAP	Challenge Handshake Authentication Protocol
CLI	Command Line Interface for Batch scripting
CSD	Circuit Switched Data
CTS	Clear to Send
dB	Decibel
dBi	Decibel Relative to an Isotropic radiator
DC	Direct Current
DCD	Data Carrier Detect
DCE	Data Communication Equipment (typically modems)
DCS 1800	Digital Cellular System, also referred to as PCN
DI	Digital Input
DO	Digital Output
DSR	Data Set Ready
DTE	Data Terminal Equipment
DTMF	Dual Tone Multi-frequency
DTR	Data Terminal Ready
EDGE	Enhanced Data rates for Global Evolution of GSM and IS-136
EMC	Electromagnetic Compatibility
EMI	Electro-Magnetic Interference
ESD	Electrostatic Discharges
ETSI	European Telecommunications Standards Institute
FDD LTE	Frequency Division Duplexing Long Term Evolution
GND	Ground
GPRS	General Packet Radio Service
GRE	generic route encapsulation
GSM	Global System for Mobile Communications
HSPA	High Speed Packet Access
ID	identification data
IMEI	International Mobile Equipment Identification
IP	Internet Protocol
IPsec	Internet Protocol Security
kBps	kbits per second
L2TP	Layer 2 Tunneling Protocol

Abbr.	Description
LAN	local area network
LED	Light Emitting Diode
M2M	Machine to Machine
MAX	Maximum
Min	Minimum
MO	Mobile Originated
MS	Mobile Station
MT	Mobile Terminated
OpenVPN	Open Virtual Private Network
PAP	Password Authentication Protocol
PC	Personal Computer
PCN	Personal Communications Network, also referred to as DCS 1800
PCS	Personal Communication System, also referred to as GSM 1900
PDU	Protocol Data Unit
PIN	Personal Identity Number
PLCs	Program Logic Control System
PPP	Point-to-point Protocol
PPTP	Point to Point Tunneling Protocol
PSU	Power Supply Unit
PUK	Personal Unblocking Key
R&TTE	Radio and Telecommunication Terminal Equipment
RF	Radio Frequency
RTS	Request to Send
RTU	Remote Terminal Unit
Rx	Receive Direction
SDK	Software Development Kit
SIM	subscriber identification module
SMA antenna	Rubber antenna or Magnet antenna
SMS	Short Message Service
SNMP	Simple Network Management Protocol
TCP/IP	Transmission Control Protocol / Internet Protocol
TE	Terminal Equipment, also referred to as DTE
Tx	Transmit Direction
UART	Universal Asynchronous Receiver-transmitter
UMTS	Universal Mobile Telecommunications System
USB	Universal Serial Bus
USSD	Unstructured Supplementary Service Data
VDC	Volts Direct Current
VLAN	Virtual Local Area Network
VPN	Virtual Private Network
VSWR	Voltage Stationary Wave Ratio

Abbr.	Description
WAN	Wide Area Network

Guangzhou Robustel Co., Ltd.

Add: 501, Building 2, No. 63, Yong'an Avenue,
Huangpu District, Guangzhou, China 510660

Tel: 86-20-82321505

Email: support@robustel.com

Web: www.robustel.com